

DYNAMIC ABUTMENT SOLUTIONS

DIGITAL SOLUTIONS

PRODUCT CATALOGUE





Virginia Woolf, 17
25005 · Lleida (Spain)

INTERNATIONAL +34 873 450 709
das@dynamicabutment.com

SPAIN +34 973 289 580
spain@dynamicabutment.com

Dynamic Abutment Solutions is the trademark of the manufacturer Talladium España S.L. The information included in this catalogue is exclusively addressed to professionals in dental sector.

All commercial trademarks mentioned herein are fully registered by their respective companies, and the images that appear are just to provide an orientation. Talladium reserves the right to modify this document without previous notice. Talladium is not responsible for the inadequate execution of these products if the warning indications corresponding to every reference are not contemplated.

Ask about the products available with CE legislation. Some of the products are not authorized for sale and distribution or do not have a sales license in some countries according to other legislations. Information: das@dynamicabutment.com.



INDEX

5	DYNAMIC ABUTMENT SOLUTIONS	26	TIBASE VALIDATION PATTERN
6	DYNAMIC SYSTEM. MILLING STRUCTURES	27	DIGITAL ANALOG VALIDATION PATTERN
8	DYNAMIC DAS SYSTEM	28	MULTI-UNIT DAS SYSTEM
10	CAD-CAM WORKFLOW	30	MULTI-UNIT WORKFLOW
12	SCANBODY OP	32	MULTI-UNIT
13	DYNAMIC SCANBODY & ADAPTOR	34	ANGULATED MULTI-UNIT
14	REFERENCE SCANBODY & PEEK PINS	35	MULTI-UNIT SCANBODY
15	CAPS. COMPLETE ARCH PILLAR SYSTEM	36	DIGITAL ANALOG
16	LAB SCANBODY	37	DYNAMIC TIBASE
17	SCANALOG	38	DIRECT TO IMPLANT
18	DYNAMIC TIBASE	39	MILLING OPTIONS
19	DYNAMIC 3TIBASE	40	DAS MU SYSTEM COMPONENTS
20	DYNAMIC TIBASE. GINGIVAL OPTIONS	42	DAS LIBRARIES
22	DYNAMIC MILLING TOOL DIRECT TO IMPLANT	44	MULTI-UNIT DAS LIBRARIES
24	DIGITAL ANALOG	45	SCREWDRIVERS AND COMPLEMENTS
25	DIGITAL ANALOG POSITIONER	46	LIST OF COMPATIBILITIES AVAILABLE

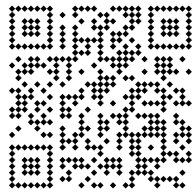

This printed version is probably outdated and may not include all products or compatibilities.

Scan and download the latest version of this catalogue

www.dynamicabutment.com



DYNAMIC ABUTMENT SOLUTIONS

In Dynamic Abutment Solutions we are devoted to the design, manufacture and marketing of products in the field of **implantology** and **dental prostheses**.

In our R&D&I centre, our **own technology** is developed to improve dental prosthesis manufacturing processes with the aim of providing innovative solutions that optimise workflows, both in terms of quality and profitability.

We also have extensive experience in the dental market: we offer **digital solutions** adapted to the various emerging technologies and guarantee high quality standards recognised by the most demanding customers.

We started our activity with the launch of the innovative **Dynamic Abutment**, conceived to modify the angulation of implants in the placement of dental prostheses. This product became a **market benchmark** for its contribution to solving positioning problems and improving the aesthetics and functionality of dental prostheses.

More than 20 years of experience have enabled us to remain a world leader in this field. In addition, we have developed a broad portfolio of abutments, products and digital resources focused on new lines of implantology for both **clinics** and **dental laboratories**.



More than 500
compatibilities



Present in more
than 60 countries



Customized
products



Full workflow
guidance

A close-up, high-contrast photograph of a dental milling tool. The tool is a long, cylindrical metal rod with a textured surface, likely titanium or stainless steel. It is positioned diagonally, with the tip pointing towards the bottom left. The tool is inserted into a circular opening in a larger, more complex metal component, which appears to be a dental abutment or implant. The lighting is dramatic, highlighting the metallic textures and the precision of the manufacturing process. The background is dark, making the metallic parts stand out.

DYNAMIC SYSTEM

MILLING STRUCTURES

The Screwdriver set of 3.0 Dynamic Abutment System is used in those cases in which **rectification of the entry of the screw** due to an unfavorable position of the implants is necessary, improving the functionality and aesthetics of the milled prosthesis.

More than 1.500.000
cases solved with
DYNAMIC SYSTEM

DYNAMIC SCREWDRIVER

Screwdriver with hexalobular head, exclusively to the 3.0 Dynamic Abutment system.

Lengths: 18, 24, 32 mm.

Our screwdriver has a **contra-angle** connection to make it easier to use with a dynamometer or manual ratchet, with the corresponding adaptors or handles.

PATENT NUMBER
Dynamic Screwdriver
EP 3 260 079

PATENT NUMBER
Dynamic Screw
US 2020/15942



HIGH DYNAMIC
SCREW

DYNAMIC
SCREW

Dynamic screws covers the majority of the thread metrics available on the market. They are used with the Dynamic TiBase or milled structures with an angled screw channel. There are **several lengths** for each metric to ease adaptation to the structures. All of them are made of Titanium grade V.

All screws are perfectly identified with their batch and reference numbers, which allow each and every screw to be **traced** and **recorded** in the patient's card and in the clinical or laboratory records. Only the 3.0 Dynamic Screwdriver may be used to install them.

DYNAMIC DAS SYSTEM





Lab Scanner



Lab Scanner



Intraoral Scanner

LAB SCAN TIBASE SYSTEM

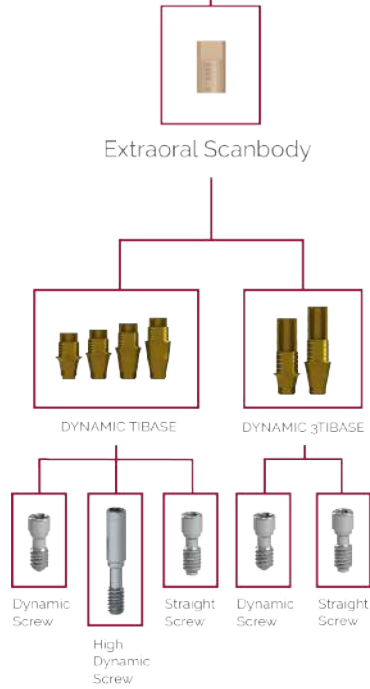

FULL SYSTEM

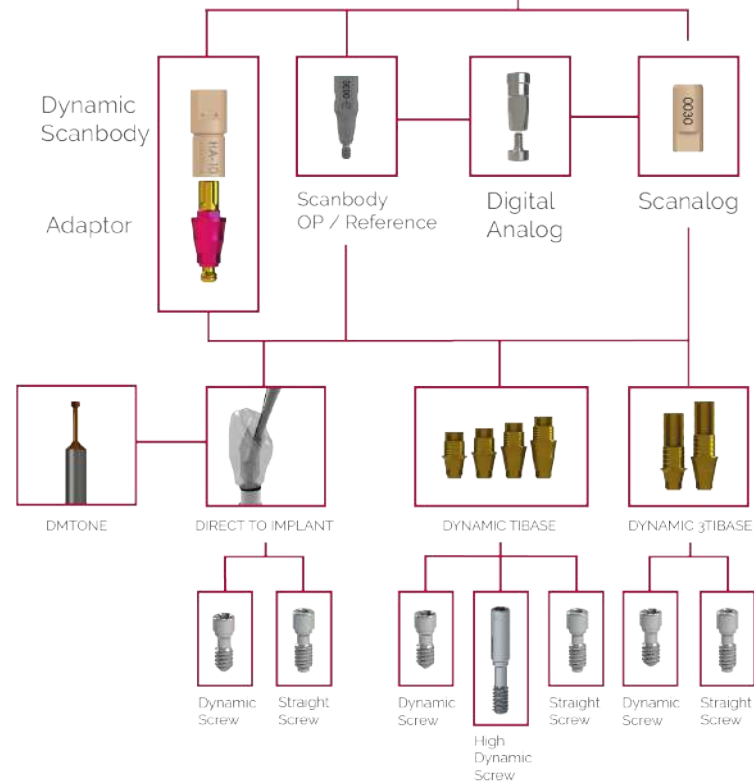

CAD-CAM WORKFLOW

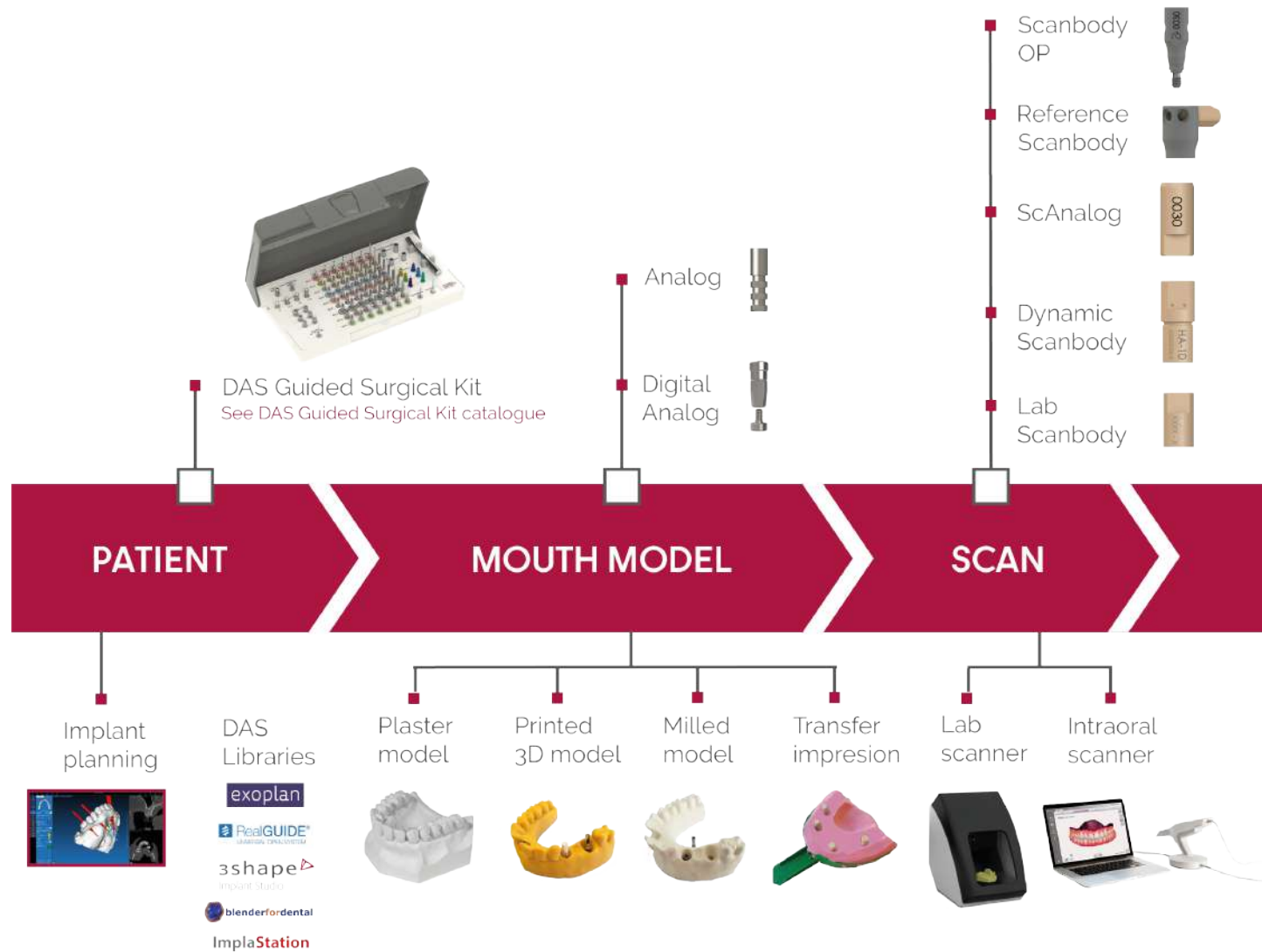

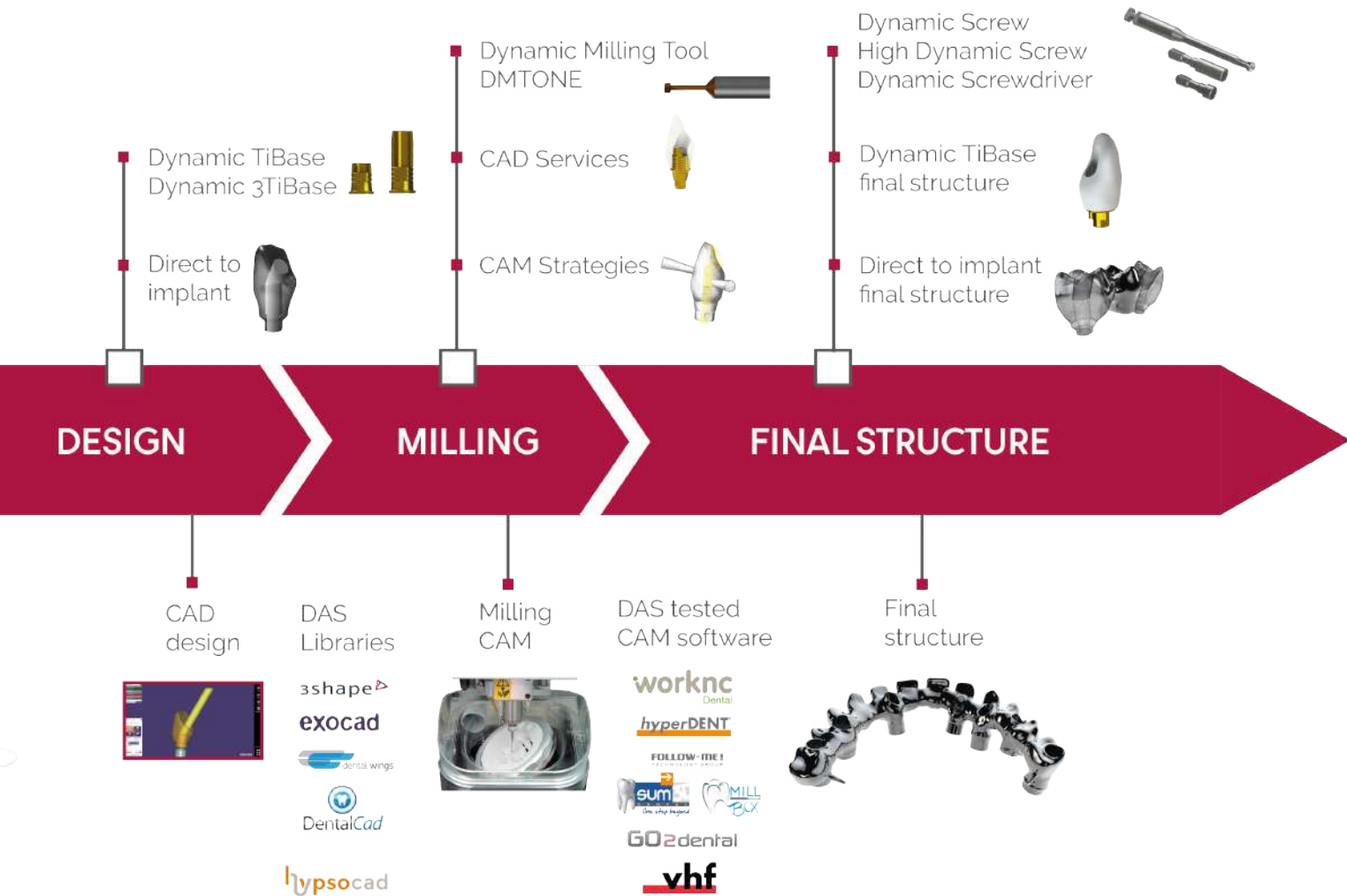

SCANBODY OP

A single piece made of titanium placed at 10mm height from the implant. It features **two thread holes** to attach Peek Pins (if it is necessary). The DAS code is printed on the surface.

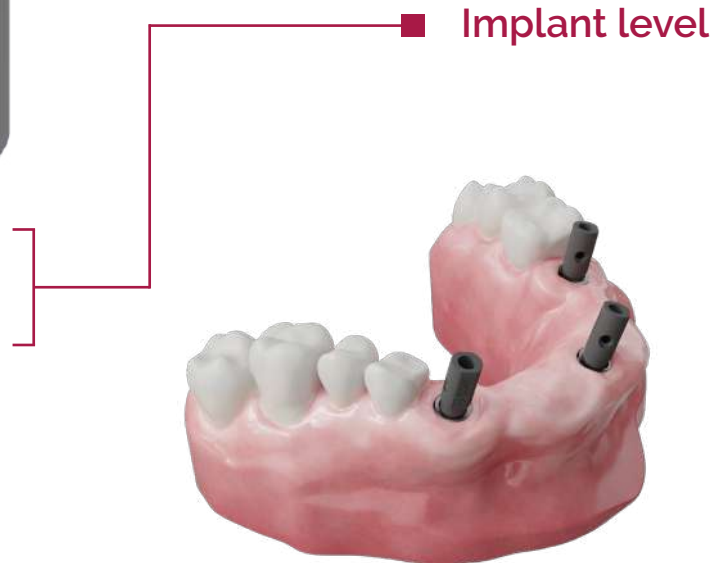

DYNAMIC SCANBODY & ADAPTOR

The scanbody detects the **position** and **orientation** of the respective dental implant or analog in CAD-CAM scanning procedures. There are **no holes** in the upper section which means the Z axis is free to improve scanbody scanning.



Hole free scanbody and not screwed

3 lengths

8 mm, 10 mm and 12 mm

For the most complex scanbody reading cases.



Connecting element between the scanbody and the implant. Marked with **different colors** according to the compatibility.



Screwed into the implant

REFERENCE SCANBODY & PEEK PINS

The Reference Scanbody is made of titanium and is designed to improve scanning for **edentulous cases**.

- Peek Pins can be used for **best scanning**
- The Reference Scanbody is compatible with different **Multi-Unit**



Peek Pins lengths

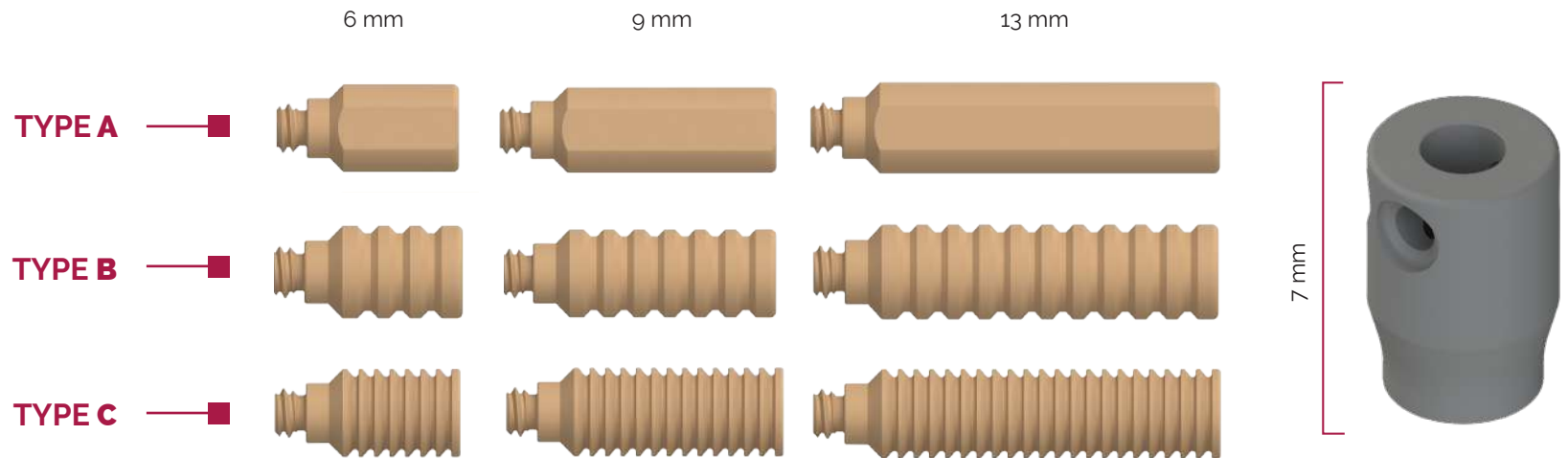

CAPS COMPLETE ARCH PILLAR SYSTEM

The Complete Arch Pillar System (CAPS) is made to improve **scan accuracy** and to **record maxilomandibular relationship** for the fabrication of a complete arch.

With the CAPS System we can finally close the Circle of **Digital Workflow** for a Complete Arch.

CAPS heights

REGULAR CAPS

4,8 mm



WIDE CAPS

6,5 mm



8 mm

6 mm

3,8 mm

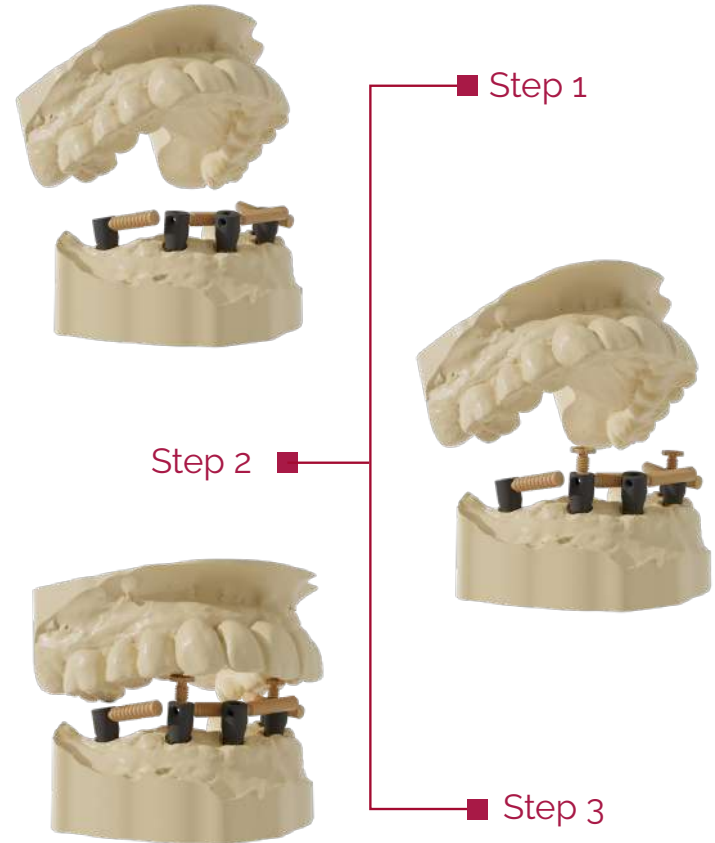

LAB SCANBODY

ONLY FOR DYNAMIC TI-BASE
AND LAB SCANNER

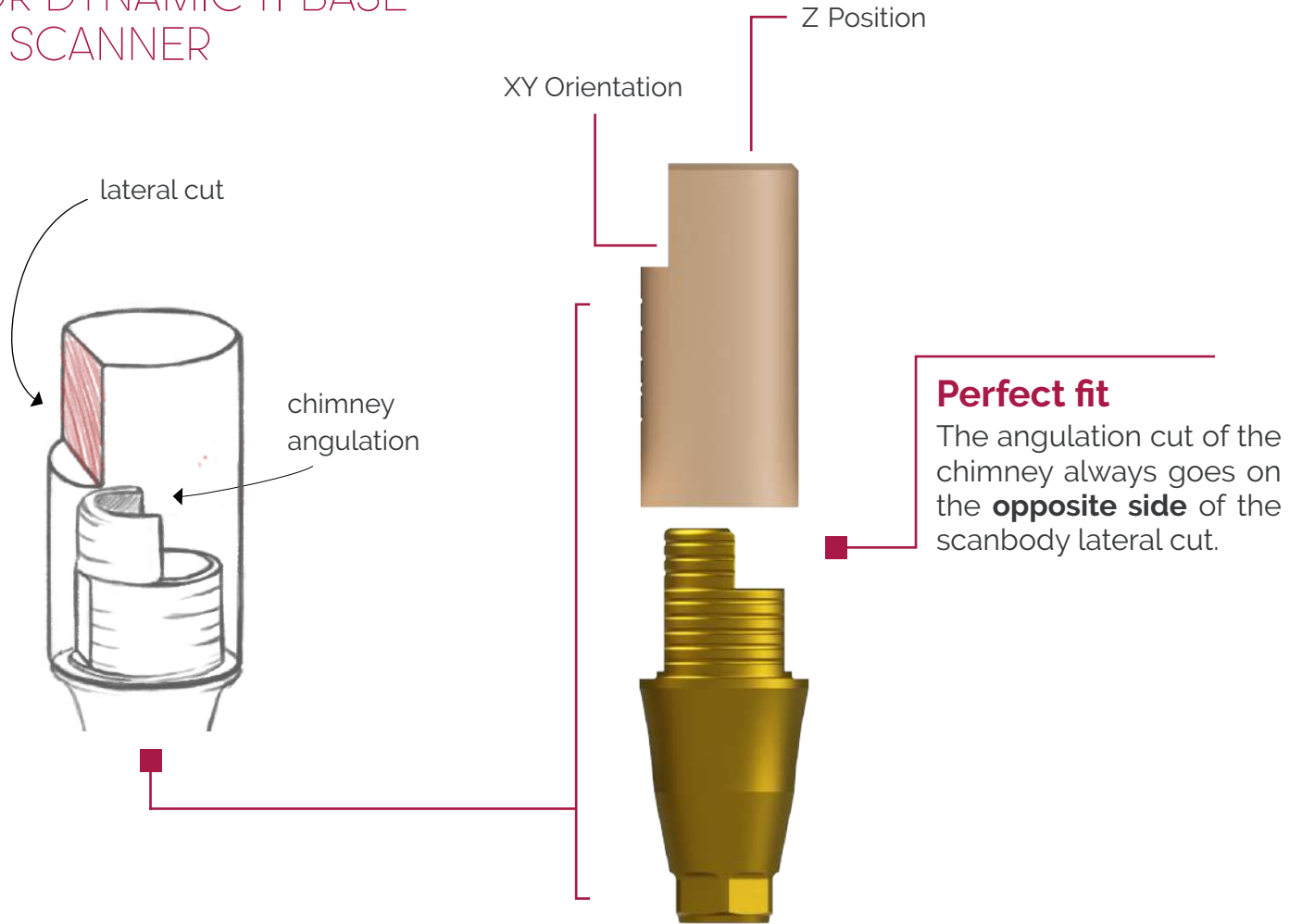

SCANALOG

SCAN DIRECTLY ON THE IMPRESSION TRAY

Allows digitalizing implant position using an **extraoral scanner** directly on the impression tray. Eliminates the need of dental plaster models.

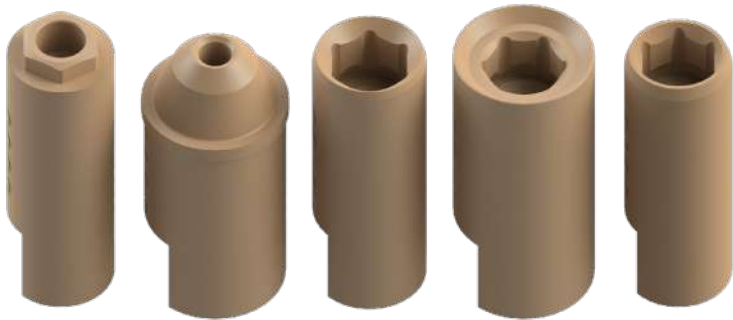

■ Scanning

Scanning process of the silicon model with the ScAnalog placed.

DYNAMIC TiBASE

Dynamic TiBases are a technological contribution to the digital treatment for the **angled systems development** using CAD-CAM. The Dynamic System includes the Dynamic TiBase, the Dynamic Screw-Screwdriver set, Scanbodies and Digital Libraries. Libraries are available for the main CAD softwares on the market: Exocad, 3Shape, Dentalwings, Dental Cad and Hypsocad.

TO CORRECT up to
ANGULATION 45°



Dynamic screw Straight screw

Maximum angulation available for the first TiBase gingival height.

Maximum angulations for the rest of gingival heights under request.



DYNAMIC 3TiBASE

The Dynamic 3TiBase offers the possibility to work with different cement heights: 5, 7 or 9 mm. It is specially designed for the cases that require **higher height**. In this way, a greater support surface is achieved, the structure is stronger and more resistant so structure breaks by height decompensation between the TiBase and the structure are avoided.

To achieve the maximum strength of the structure it is important to have the maximum support surface possible



Precision machined up to +/- 5 microns



Scan with the Dynamic Scanbody or OP and cement the final piece onto the 3TiBase



If you do not have the Dynamic or the OP Scanbody, it is necessary to use the 4 mm TiBase (the smallest gingival height of its compatibility) and the Lab Scanbody to make the scanning. The final piece is cemented onto the 3TiBase.

DYNAMIC TIBASE

GINGIVAL OPTIONS



45°

25°

20°

15°

10°



GH- 0.6 mm Dynamic Screw

GH- 1.5 mm Dynamic Screw

GH- 3 mm Dynamic Screw

GH- 4 mm Dynamic Screw

GH- 5 mm Dynamic Screw

30°

25°

30°

30°

23°

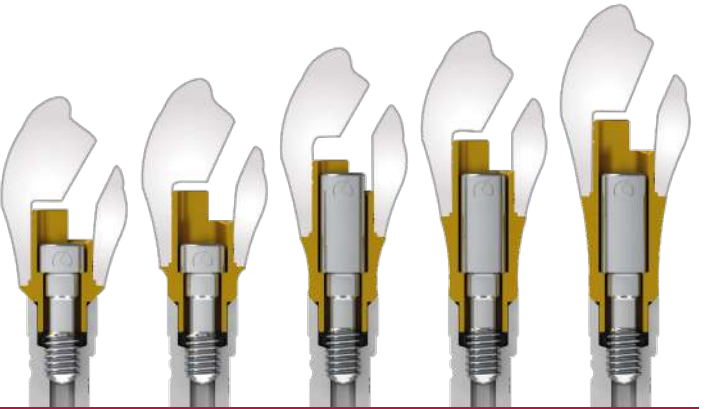

GH- 0.6 mm Dynamic Screw

GH- 1.5 mm Dynamic Screw

GH- 3 mm High Dynamic Screw

GH- 4 mm High Dynamic Screw

GH- 5 mm High Dynamic Screw

STANDARD SYSTEM

Example with TiBase compatible with Zimmer Screw-Vent Ø3,5 (Code 0040)



Dynamic Screw

CAPTIVE SYSTEM



Dynamic Screw



High Dynamic Screw

- Keep the angulation
- Better aesthetic angled channel Ø2 mm
- Angled channel reduction up to 32%
- Increases the volume of the structure
- Captive Screw (first screw on the TiBase before cementing)

DYNAMIC MILLING TOOL

Precision milling tool. For screwed angled structure direct to implant.

It is used to **mill the screw seating** and to **increase the internal diameter** of the straight channel.

DIRECT TO IMPLANT ONE PIECE

There are different tools depending on compatibility, screw seating, metric and length.

There are **3 cutting wing-tips** with **3 different cutting area** each.

Shank
Ø3, Ø4, Ø6

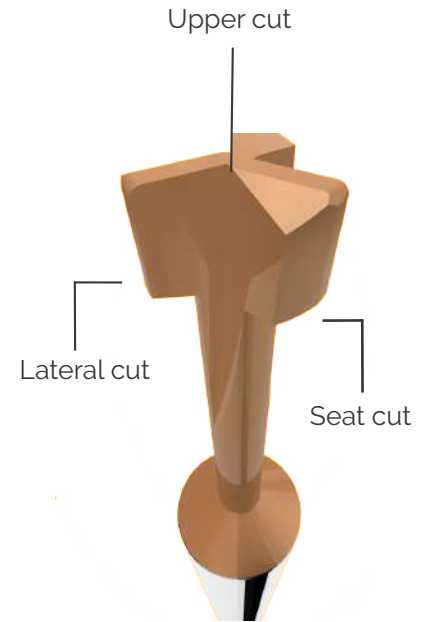
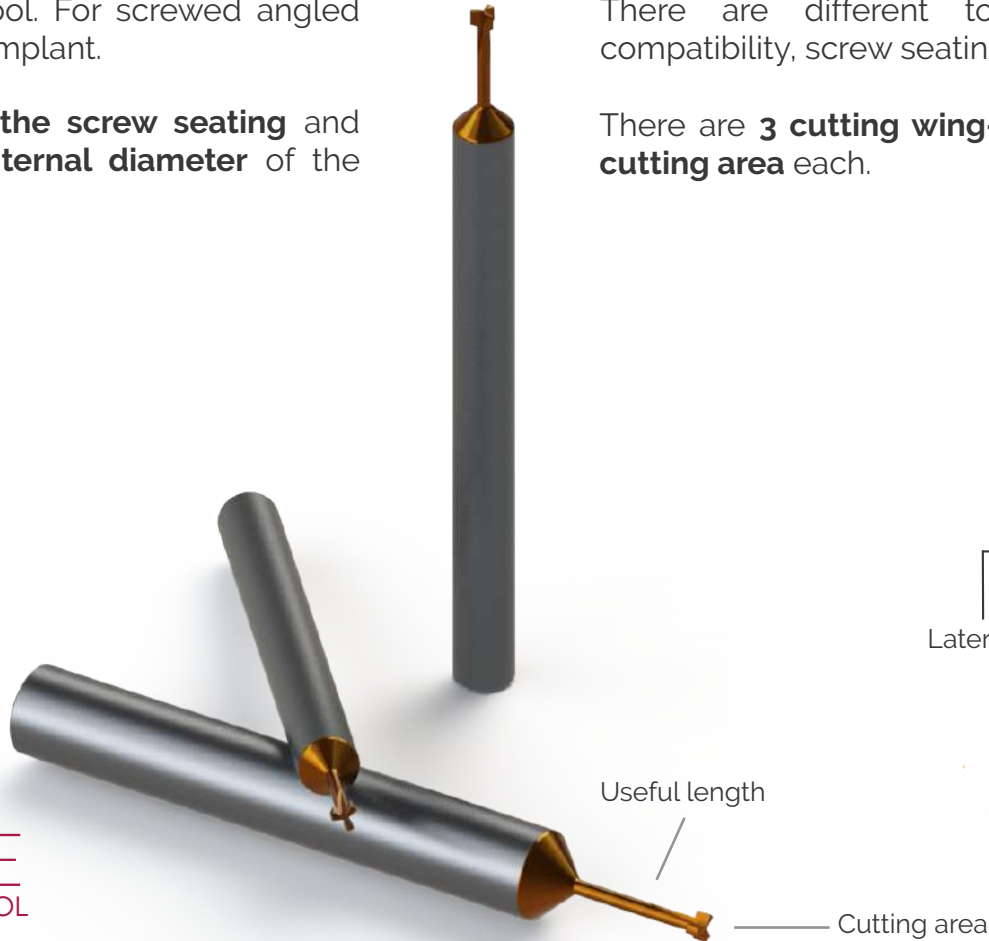

DMTONE
DYNAMIC MILLING TOOL



STEP 1:
Crown with pre-drill

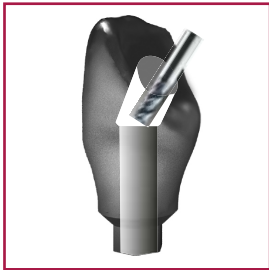

STEP 2:
Crown with angled channel

STEP 3:
Crown with Dynamic Milling Tool

Milling the screw seat and increasing the diameter of the straight channel.

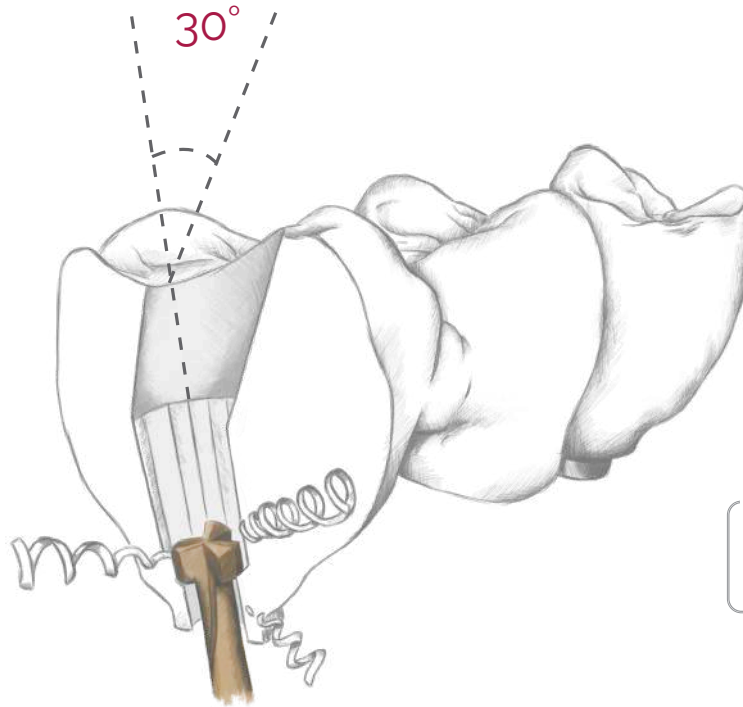

PATENT NUMBER
Milling process of the
angulated channel
ES 2658 985

Tested and validated by

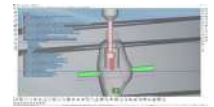

DIGITAL ANALOG

Digital Analog to simulate the implant position in a 3D printed dental model.



3shape
Model Builder



exocad
Model Creator



dental wings
Model Builder

3D PRINTED MODEL

The dental model -for later insertion of the analogs- is designed using the CAD libraries.

DIGITAL ANALOG POSITIONER

1. Insert the DA positioner inside the 3D printed model (Fig. 1).
2. Screw the bottom part of the digital analog onto the part of the DA positioner (Fig. 2).
3. Slide the analog downwards aligning the flat face of the analog with the flat face of the 3D printed model.
4. Screw in component 2 (Fig. 4) so the analog is positioned correctly (Fig. 3).
5. Unscrew component 1 (Fig. 4) of the positioner.
6. Screw the fastening screw into the digital analog using a compatible screwdriver manually (maximum torque of 10 N cm).

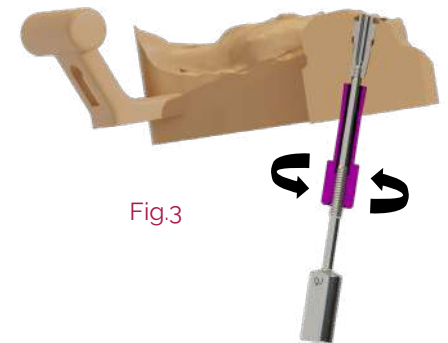
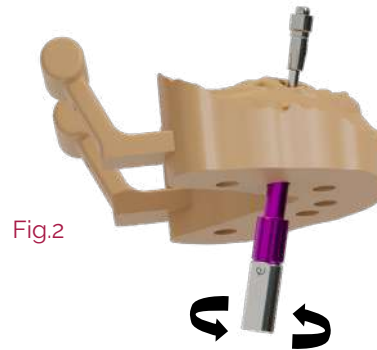
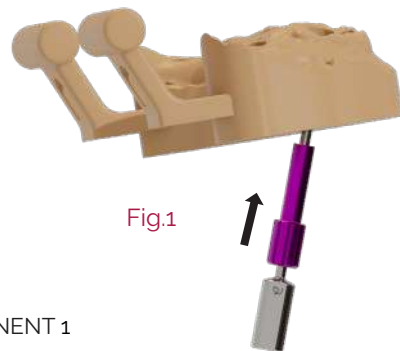

Screwed fastening

Prevents the analog from moving in Z

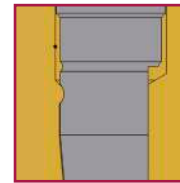

Longitudinal cut

Longitudinal cut to avoid rotation X-Y

Concave notch

Top precision in longitudinal position

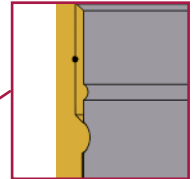

Curved Surface

Accuracy of orientation guaranteed

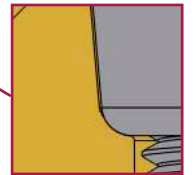

TIBASE VALIDATION PATTERN

The validation pattern for TiBase is an STL file that contains different **cement gaps**, ranging from 50 microns, which comes by default in the library to values of 10, 20, 30, 40, 60, 70 and 80 microns.

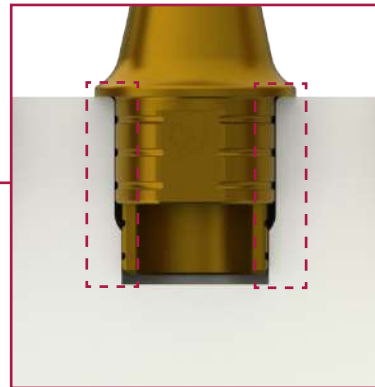
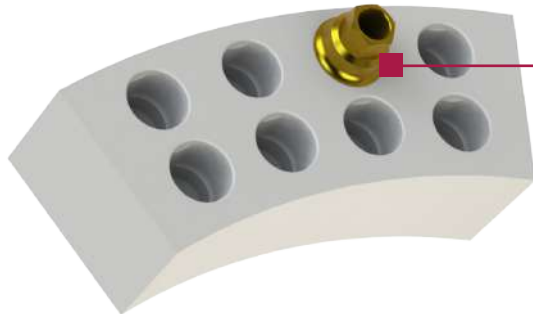
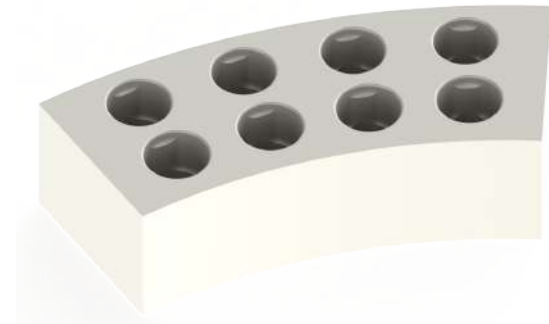
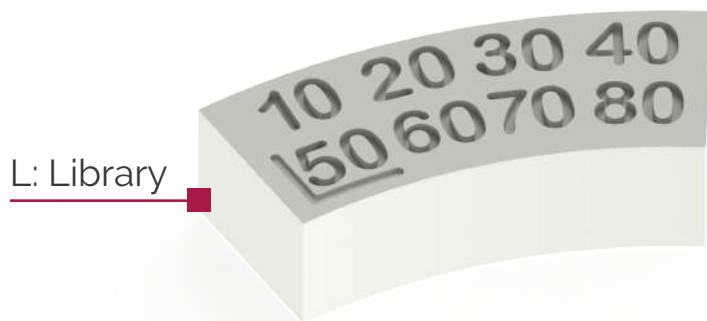

This pattern is to establish the **cementation space**, according to the client's convenience, for each case between the TiBase and the material.

DIGITAL ANALOG VALIDATION PATTERN

The validation pattern for Digital Analogs is an STL file that contains different **printing gaps**, ranging from 30 microns which comes by default in the library to values of -10, 10, 50, and 70 microns.

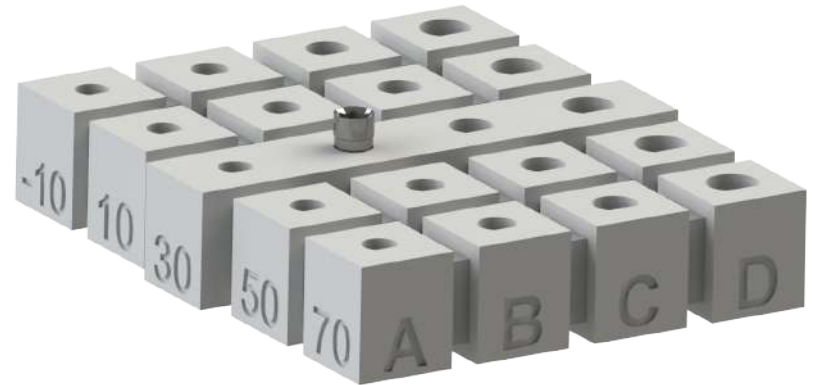

This pattern is used to know which is the **ideal gap** for the printer being used.

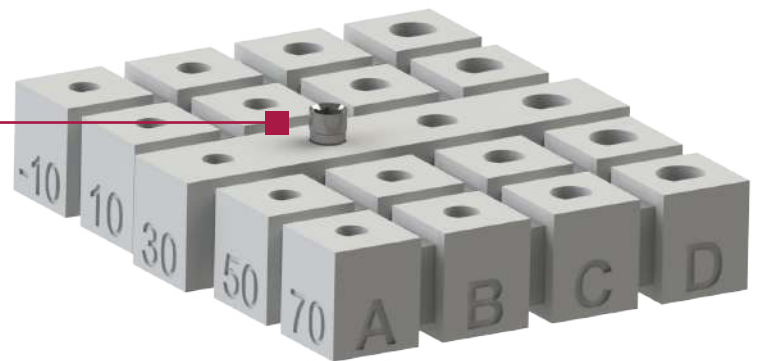
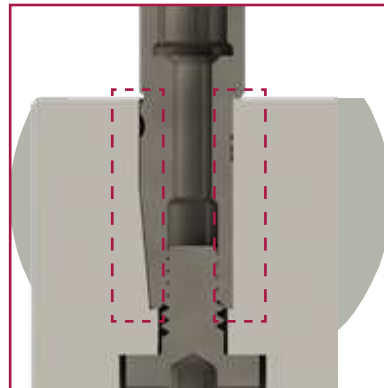

MULTI-UNIT DAS SYSTEM



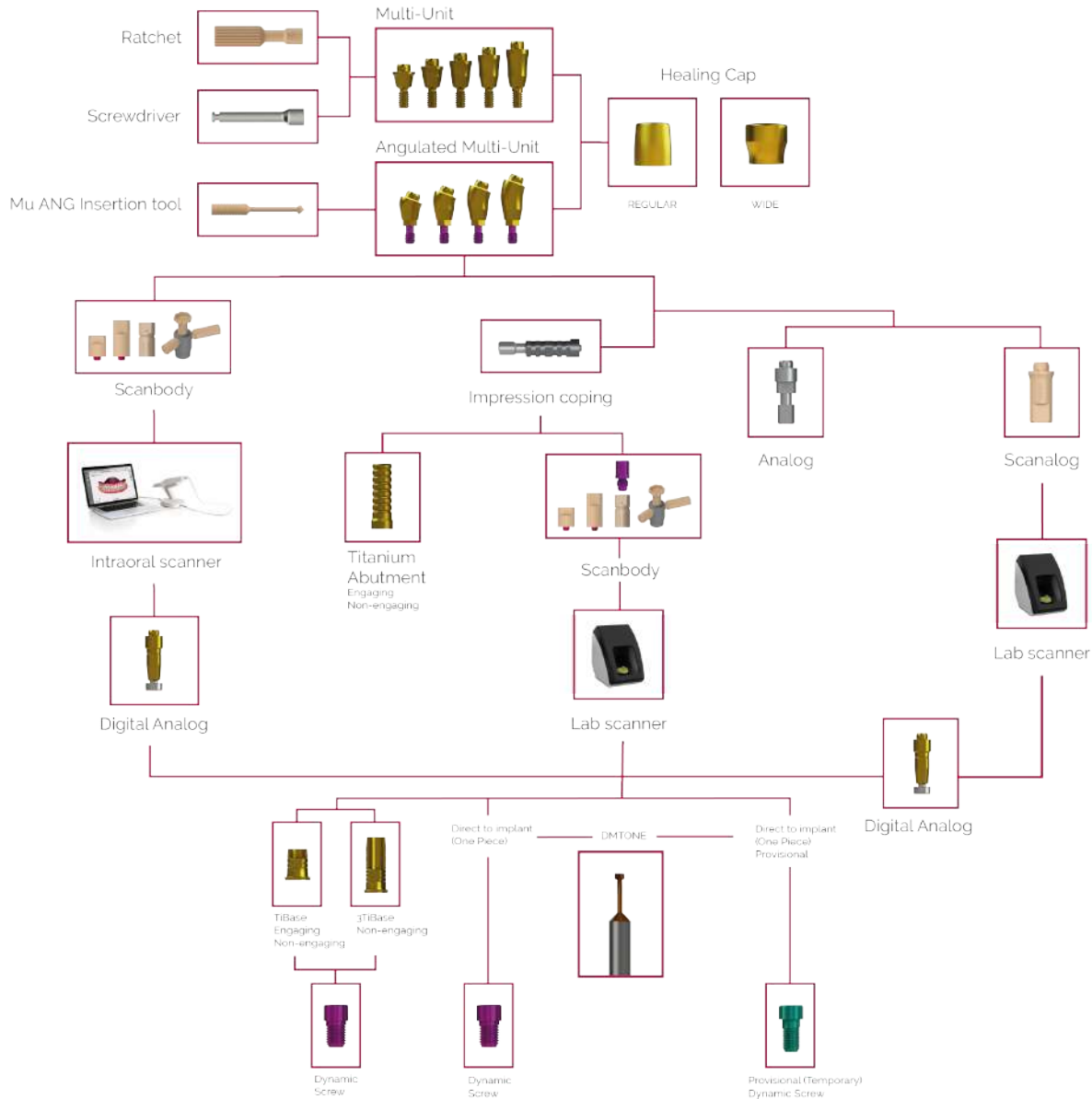

MULTI-UNIT WORKFLOW

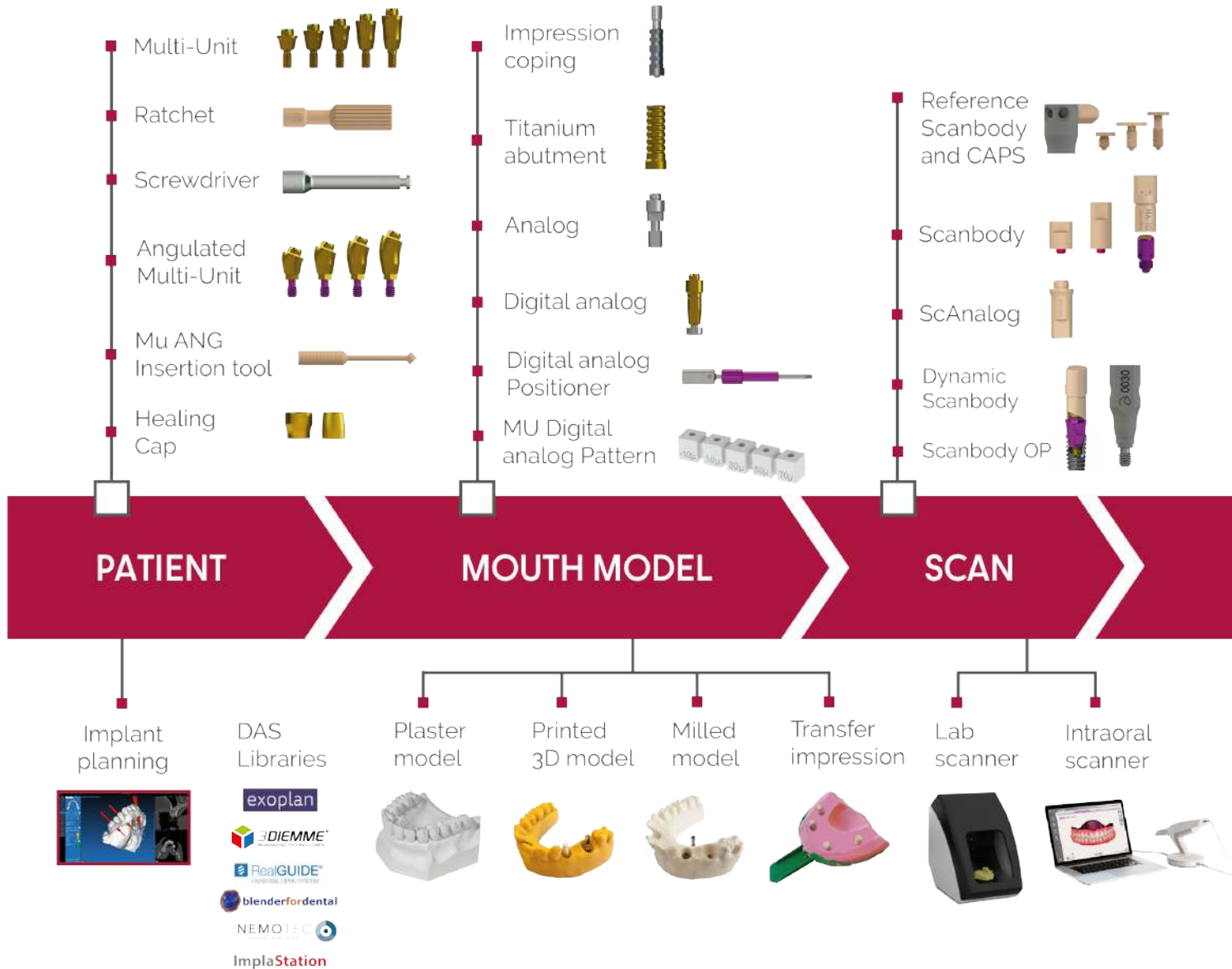

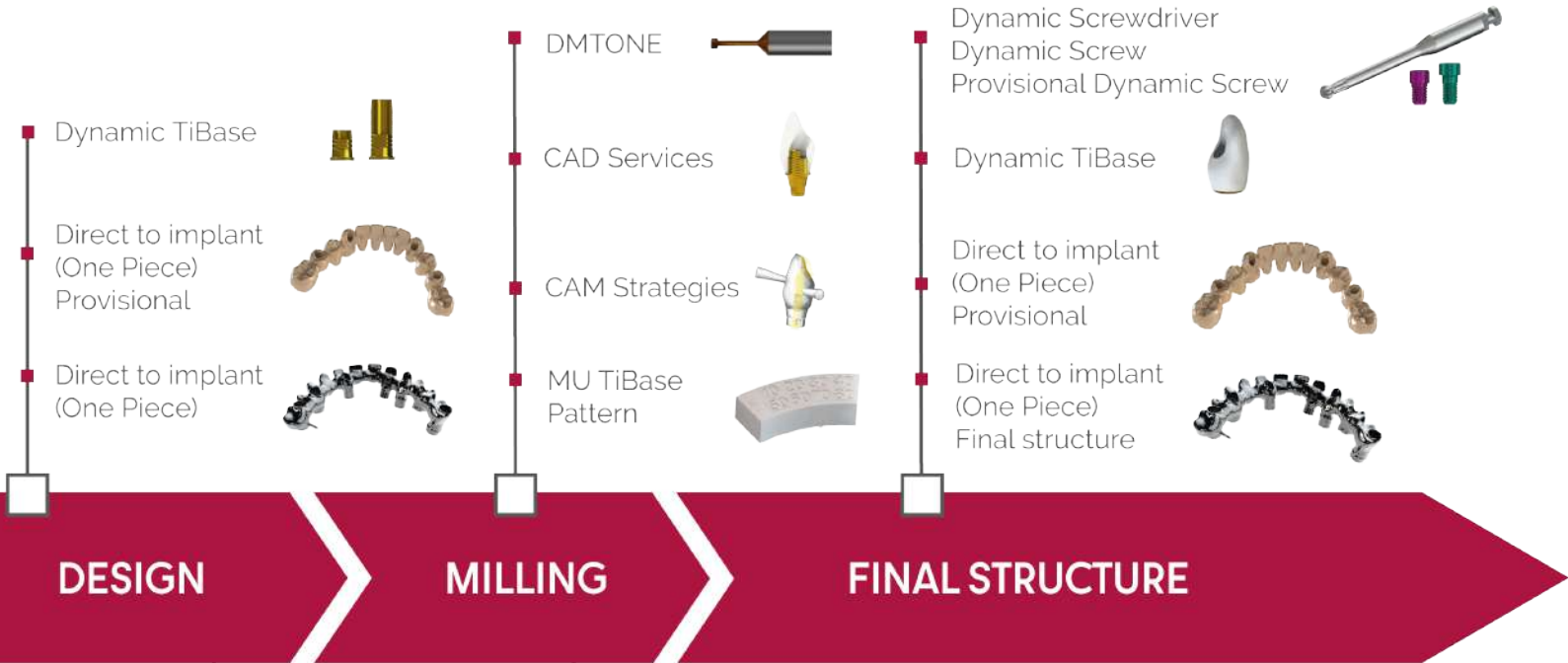

CAD design

DAS Libraries

3shape

exocad

dental wings

DentalCad

hypsocad

Milling CAM

DAS tested CAM software

worknc Dental

hyperDENT

FOLLOW-ME!

sum

MILL 3X

GO2dental

vhf

MULTI-UNIT

The Multi-Unit (MU) abutment has been carefully designed to rehabilitate partially or fully edentulous arches, as well as individual.

Maximum diameter of the MU is 4 mm.
By being narrower it avoids contact with the bone



Lower cone height allows greater disparallelism than the classic MU

Concave design facilitates healing and soft tissue adaptation

Divergence between implants: 50°

Available in different gingival heights



MU INSERTION PROCEDURE

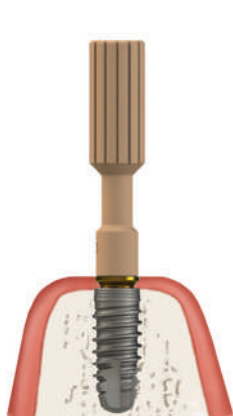

STEP 1:
Use the plastic gripping tool to attach the MU to the implant

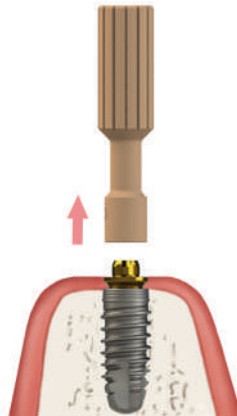

STEP 2:
Remove the plastic tool



STEP 3:
Tighten MU to **30 N.cm** using the MU Screwdriver

MU HEALING CAPS

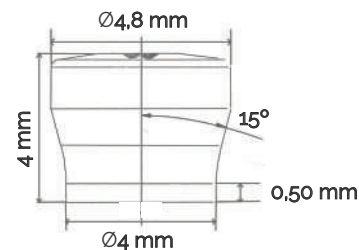
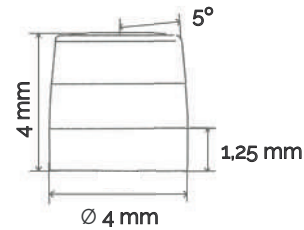

ANGULATED MULTI-UNIT



- DIFFERENT **GINGIVAL HEIGHTS**
- **20°** ANGULATION
- **4MM** PLATFORM DIAMETER
- **SAME COMPONENTS** AS THE STRAIGHT

Available in different gingival heights

*Check compatibility in the reference catalogue

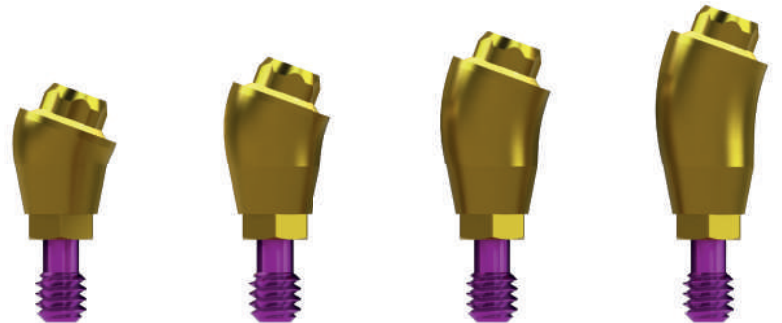

1,5mm / 2,9mm

2,5mm / 3,9mm

3,5mm / 4,9mm

4,5mm / 5,9mm

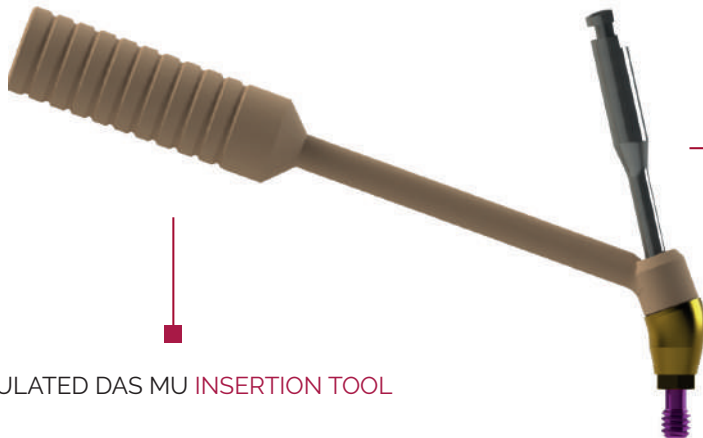

■ **DYNAMIC SCREWDRIVER** IS USED FOR ITS PLACEMENT

■ **ANGULATED DAS MU**

ANGULATED DAS MU **INSERTION TOOL**

MULTI-UNIT SCANBODY

There are four different scanbodies available in order to choose in which situation it is better to use 4,5 mm, 8 mm, Dynamic Scanbody with magnet system and Reference.

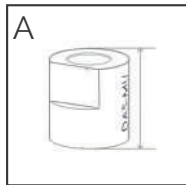

4,5 mm

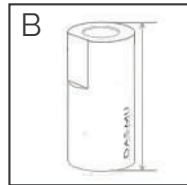

8 mm
For non-engaging
prosthetic options only

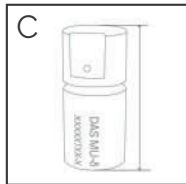

8 mm

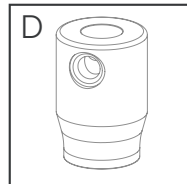

For C and D more information on
page 12 (Dynamic Scanbody) and
page 14 (Scanbody Reference)



For A and B the screw is captive inside the scanbody

MULTI-UNIT SCANALOG

Allows **digitalizing implant position** using an extraoral scanner directly on the impression tray. Eliminates the need of dental plaster models.

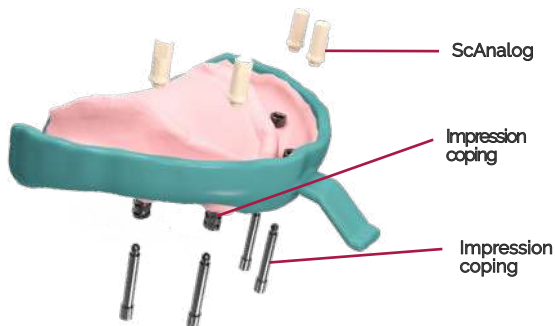

DYNAMIC SCANBODY / OP

All components of the MU DAS System can also be used with the Dynamic Scanbody or One Piece to scan direct to implant and select virtually the **ideal gingival height MU**.

For non-engaging prosthetic options only



DIGITAL ANALOG

Digital analog of the dental implant to simulate implant position in a 3D printed dental model.

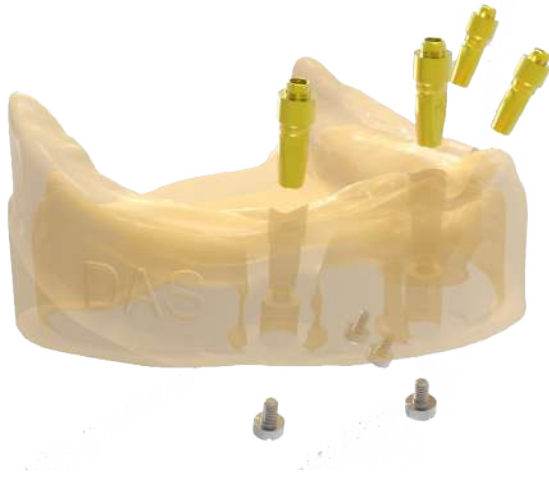

ANALOG



Traditional analog for plaster model also available

Concave notch

Top precision in longitudinal position

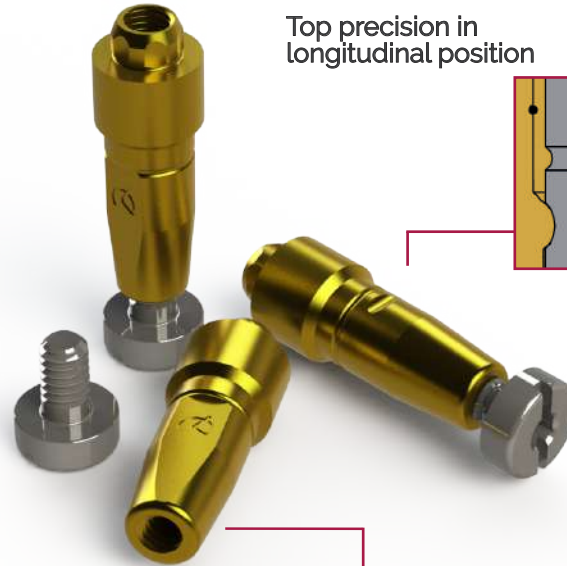
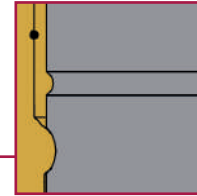

Screwed fastening

Prevents the analog from moving in Z

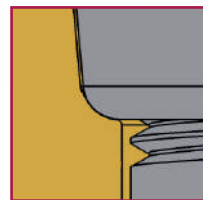

Curved surface

Accuracy of orientation guaranteed

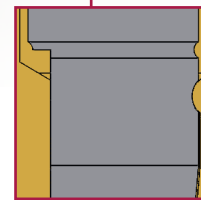

Longitudinal cut

Longitudinal cut to avoid rotation X-Y

DYNAMIC TIBASE

TO CORRECT ANGULATION

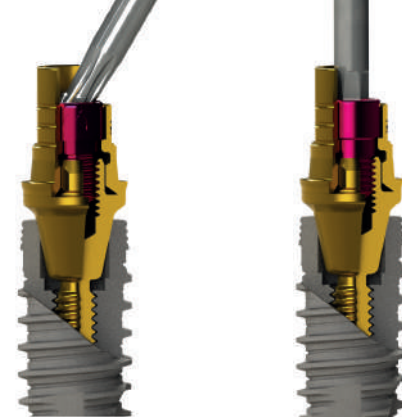

Angulated Screw Channel

Straight Screw Channel



TIBASE
ENGAGING



TIBASE
ENGAGING



3TIBASE
NON ENGAGING

CAD DESIGN

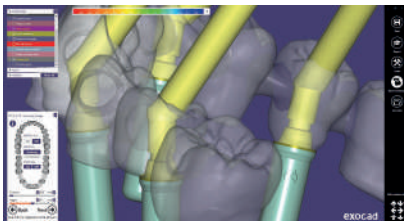

3shape

exocad

dental wings

DAS Multi-Unit system allows to change the MU in the library **without rescanning or redesigning** the case. That eases the lab and clinic work, as technician can change the MU without the need to make a new appointment with the patient to re-scan.

If we make a NR case, the option of changing MU is not allowed in the design.

DIRECT TO IMPLANT ONE PIECE

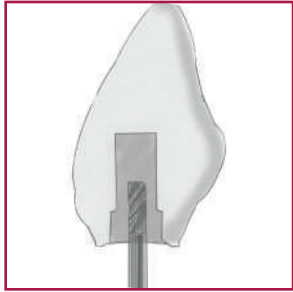

Step 1
Crown with pre drill

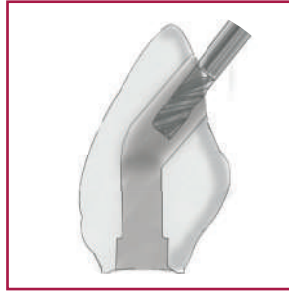

Step 2
Crown with angled channel

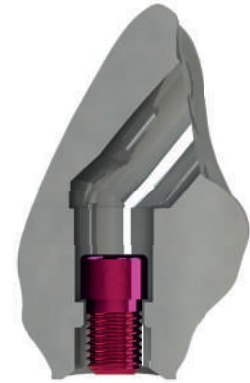

Final restorations 0-45°
Direct to implant libraries available R/NR
R = Non engaging | NR = Engaging

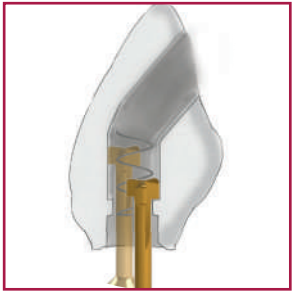

Step 3
DMTone
Crown with Dynamic Milling Tool. Milling the screw seat and increasing the diameter of the straight channel

DMTONE DYNAMIC MILLING TOOL



Dynamic screw



Provisional (temporary) Dynamic screw

Greater seating thickness
Greater contact surface between the screw and the material for greater safety in soft materials



Provisional (temporary) restorations up to 35°
Provisional (temporary) direct to implant libraries available R/NR

MILLING OPTIONS



Non engaging restoration

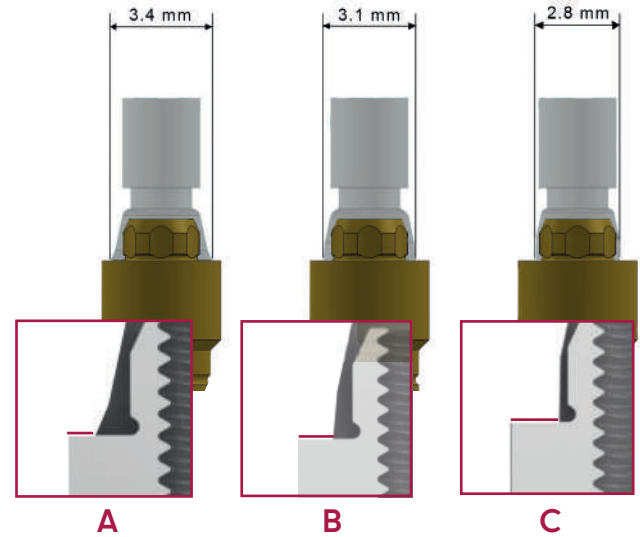

The greater the support surface,
the lesser the degree of divergence.



A

Option A: Default in the DAS library

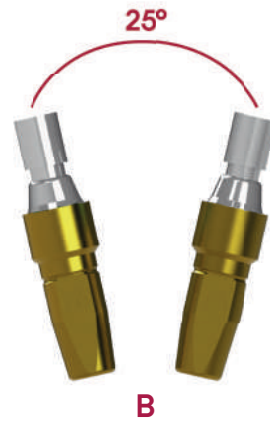

B

Options B and C: Contact das@dynamicabutment.com



C

DAS MU SYSTEM COMPONENTS



Ratchet
49.409.000.01-2



Analog
22.612.209.01-2



MU Scanbody 8 mm
53.422.209.02-2 (Non-engaging)



Screwdriver
43.321.316.01-2



Titanium Abutment
35.312.209.21-2 (Non-engaging)
35.322.209.21-2 (Engaging)



MU Dynamic Scanbody
52.408.137.01-2



MU ANG Insertion
49.422.000.01-2



Digital Analog
34.312.209.01-2



Dynamic Scanbody Adaptor
50.312.209.01-2



Healing Cap Regular
40.320.003.88-2



Digital Analog Positioner
49.309.000.01-2



Screwdriver Adaptor
43.621.410.01-2
43.624.410.01-2



Healing Cap Wide
40.320.003.89-2



MU ScAnalog
23.412.209.01-2



Impression coping
29.301.000.10-2 (Non-engaging)
29.301.000.11-2 (Engaging)



MU Scanbody 4,5 mm
53.412.209.01-2



Reference Scanbody

54.322.209.31-2

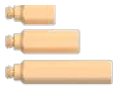

Peek Pins

TYPE A

49.414.000.01-2 (6 mm)

49.415.000.01-2 (9 mm)

49.416.000.01-2 (13 mm)

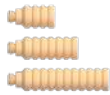

TYPE B

49.414.000.02-2 (6 mm)

49.415.000.02-2 (9 mm)

49.416.000.02-2 (13 mm)



TYPE C

49.414.000.03-2 (6 mm)

49.415.000.03-2 (9 mm)

49.416.000.03-2 (13 mm)

CAPS

Regular

49.418.000.01-2 (3,8 mm)

49.419.000.01-2 (6 mm)

49.420.000.01-2 (8 mm)



Wide

49.418.000.02-2 (3,8 mm)

49.419.000.02-2 (6 mm)

49.420.000.02-2 (8 mm)



MU Dynamic TiBase

31.312.209.01-2 (Engaging)

31.322.209.01-2 (Non-engaging)



MU Dynamic 3TiBase

31.322.209.21-2 (Non-engaging)



Dynamic Screw

41.320.040.01-2



Provisional (temporary) Dynamic Screw

41.320.050.02-2



Straight Screw

40.320.003.06-2



Dynamic Screwdriver

43.618.201.01-2 (18 mm)

43.624.201.01-2 (24 mm)

43.632.201.01-2 (32 mm)



Screwdriver Hex.1,2

43.601.103.02-2



MU DMtone

33.391.716.01-2 Shank Ø3

33.491.716.01-2 Shank Ø4

33.691.716.01-2 Shank Ø6

DAS LIBRARIES

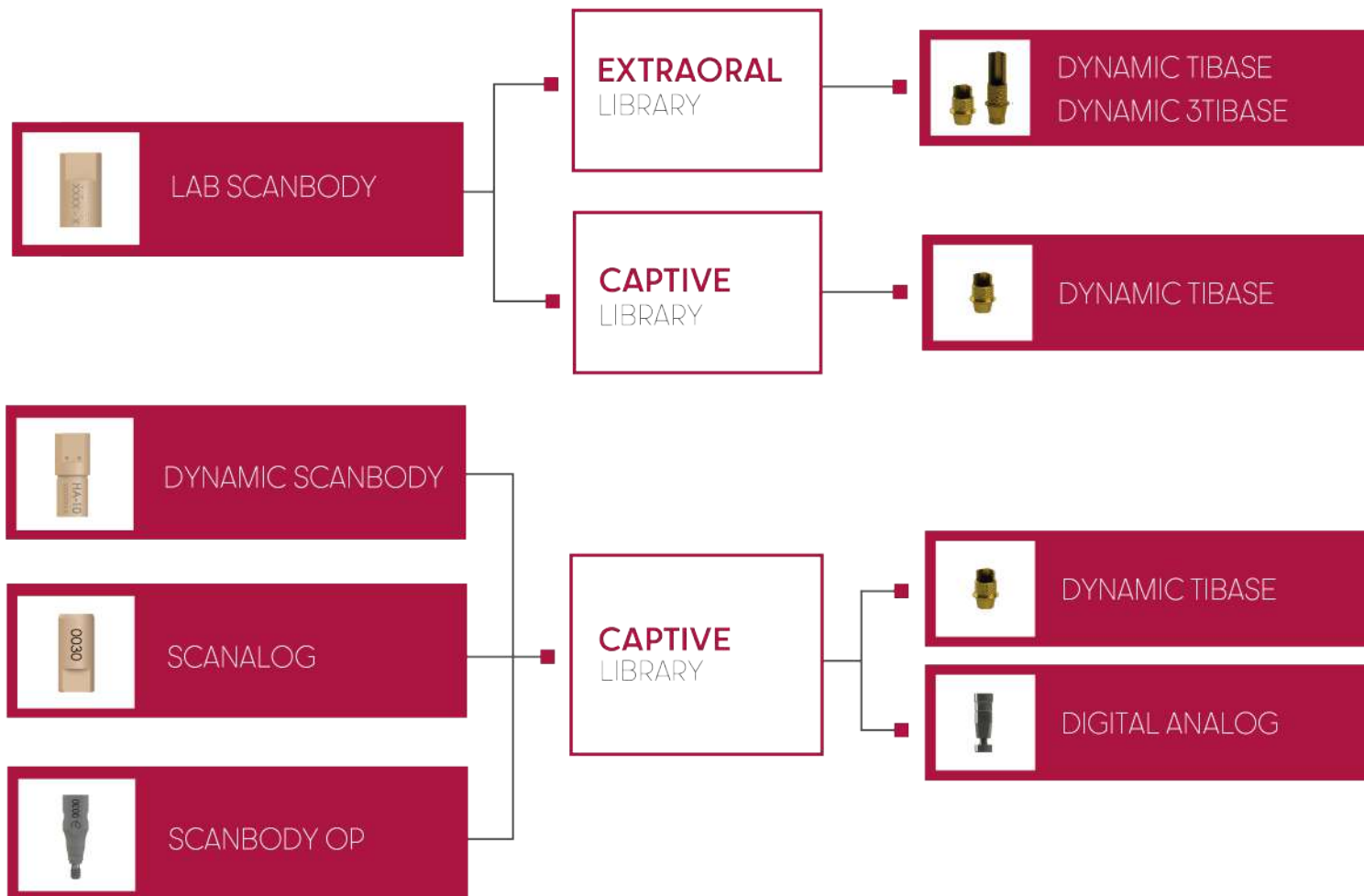

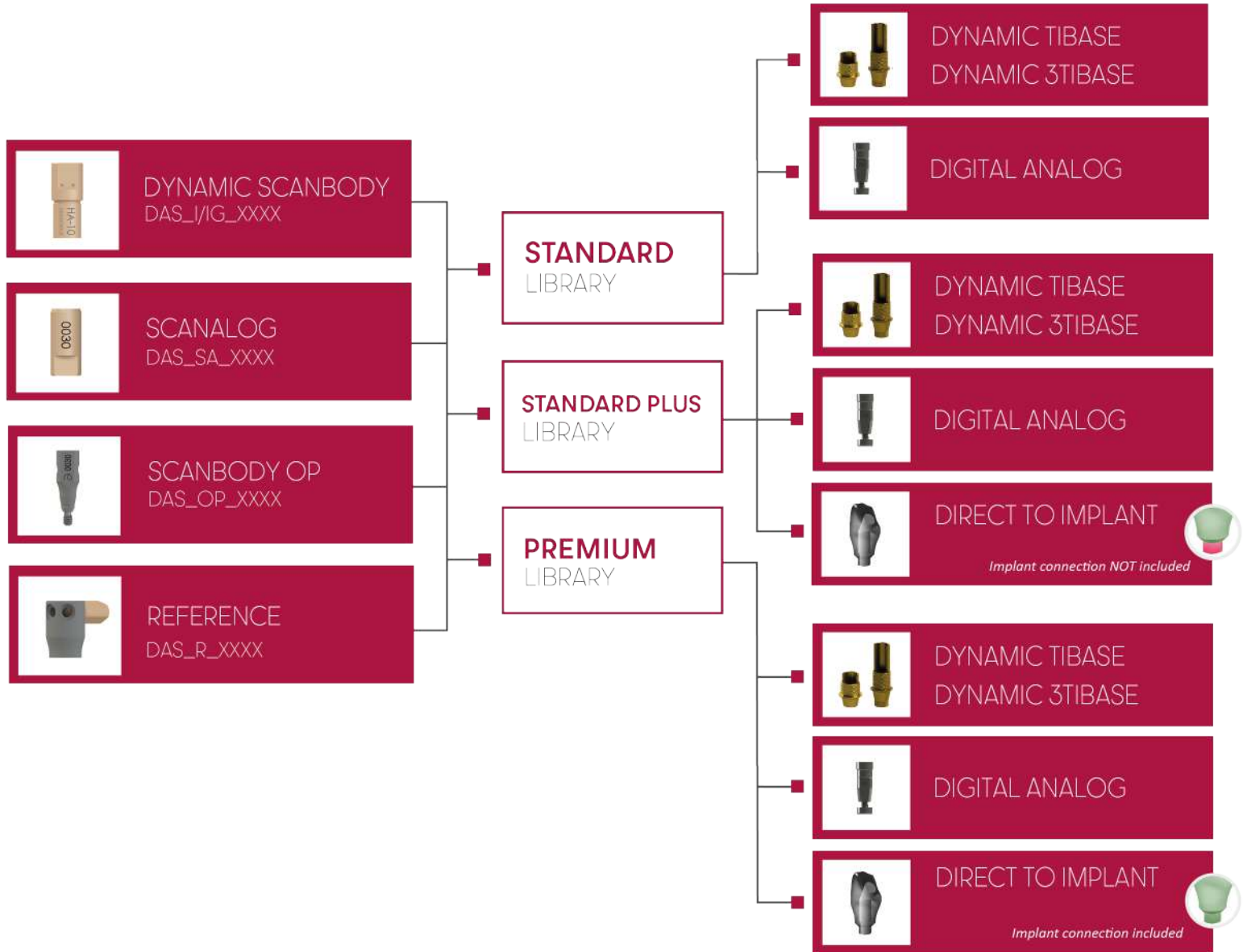

MULTI-UNIT DAS LIBRARIES

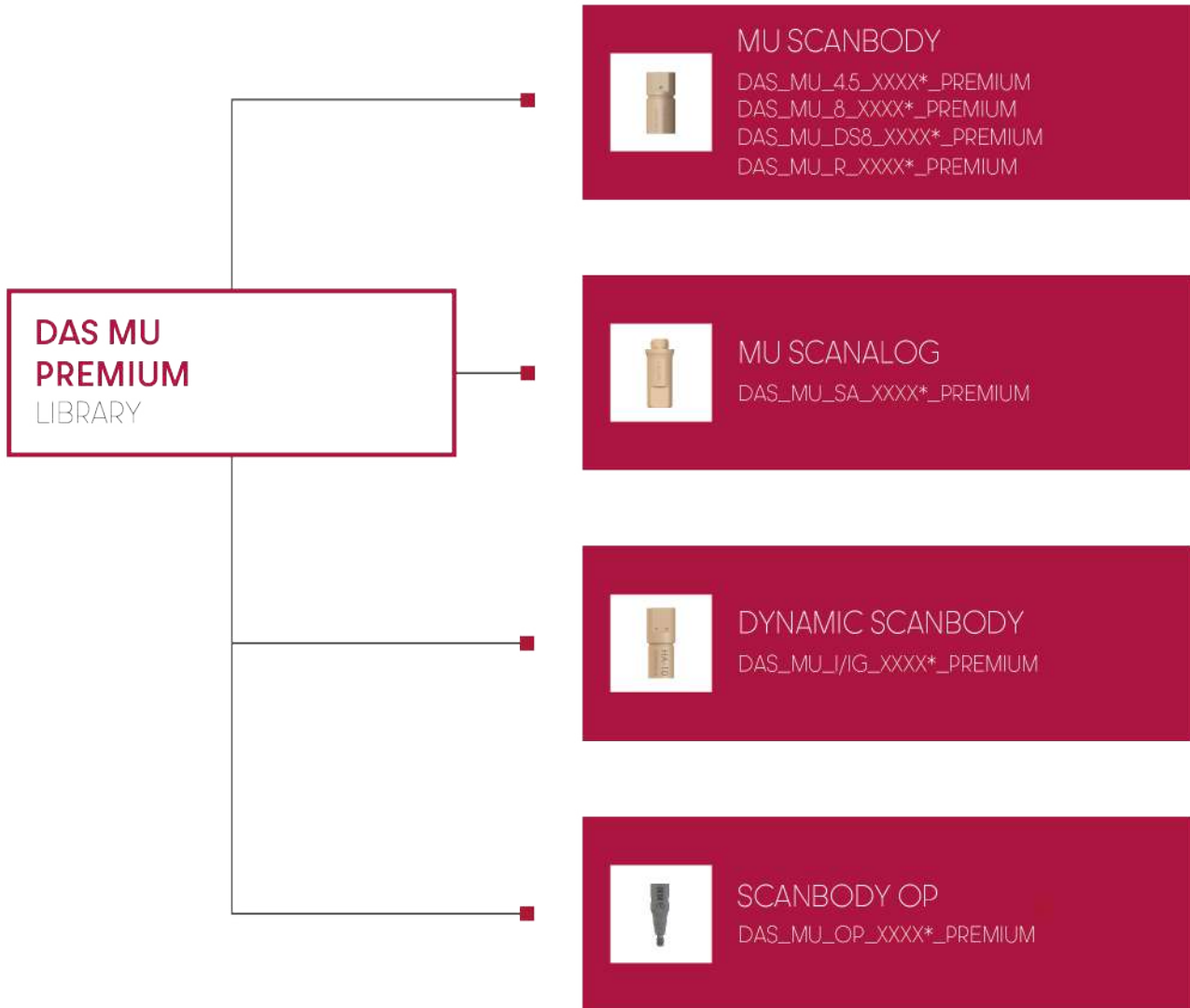

SCREWDRIVER ADAPTOR

Screwdriver for the Dynamic Scanbody System

Ref. 43.621.410.01-2

Screwdriver with manual handle
Standard length: 21 mm



Ref. 43.624.410.01-2

Contra-angle
Length: 24 mm



Ref. 43.621.415.01-2

Tiny Screwdriver with manual handle
Length: 21 mm



Ref. 43.620.411.01-2

Multi-Unit
Contra-angle
Length: 20 mm



COMPLEMENTS

Manual handle

Made of stainless steel.
They are used to connect screwdriver bits with the contra-angle connection



Large manual handle for laboratory

Ref. 49.601.000.03-2

Ideal to manipulate models in the laboratory
Length: 55,65 mm



Manual handle for clinic

Ref. 49.601.000.01-2

Clinic handle: used to position the prosthesis in the mouth prior to torque control in the clinic.
Length: 15,65 mm



Universal manual torque wrench prosthetic

Ref. 11.990.990.07-2

Torque wrench
4 mm square connection.
Torque 10-35N.c



Dynamic Screw Transfer

Ref. 49.413.000.01-2

Manual torque wrench adapter prosthetic

Piece to connect the screwdriver with contra-angle connection to the torque wrench.



Universal Manual torque wrench adapter
Ref. 49.604.000.05-2
4 mm Square connection



Straumann Manual torque wrench adapter
Ref. 49.604.000.07-2
Straumann connection



Nobel Biocare Manual torque wrench adapter
Ref. 49.604.000.08-2



MIS Manual torque wrench adapter
Ref. 49.604.000.09-2

DYNAMIC SCREWDRIVERS

Screwdriver with hexalobular head, exclusively to the 3.0 Dynamic Abutment System.
Lengths: 18, 24, 32 mm

Hexalobular 1,70 mm. Length: 18 mm

Ref. 43.618.201.01-2



Hexalobular 1,70 mm. Length: 24 mm

Ref. 43.624.201.01-2



Hexalobular 1,70 mm Length: 32 mm

Ref. 43.632.201.01-2



LIST OF COMPATIBILITIES AVAILABLE

AB	BIOTEC	EASY IMPLANT	JDENTALCARE	NOVA IMPLANTS	STRAUMANN
ACE	BIOTEM	ECKERMANN	KEYSTONE	OSSTEM IMPLANT	SURCAM DENTAL
ADIN	BREIDENT MEDICAL	ELITE MEDICA	KLOCKNER	OSTEOPUS	SYBRON IMPLANT SOLUTIONS
ALFA-GATE	BTI	EUROTEKNIKA	KUWOTECH	OXY	SYSTHEX
ALPHABIO	BTK	F&B IMPLANT (FIT & BRILLIANT)	LASAK	PALTOP	TBR
ALPHA-DENT	CAMLOG	GALIMPLANT	LEADER	PHIBO	TITANIUM-FIX
ANCLADEN	CONEXÃO SISTEMA DE PRÓTESE	GC TECH	MEDENTIKA	POINT IMPLANT	TREE-OSS
ANKYLOS	CORTEX	GMI (ILERIMPLANT)	MEDENTIS	PROCLINIC	TRI DENTAL IMPLANTS
ANTHOGYR	COWELLMEDI	GT MEDICAL	MEGAGEN	PROTEG IMPLANTS	TRINON
ARDS	C-TECH	HAHN IMPLANT (GLIDEWELL)	MICRODENT	RADHEX	UFIT
ASTRA	DENTAL TECH	HIOSSEN	MIS	REFLECT	VULKAN IMPLANTS
AVINENT	DENTAURUM	HI-TEC	MONOIMPLANT	RITTER	WARANTEC (ONEPLANT)
B&W	DENTEGRIS	IBS	MOZO-GRAU (TICARE)	ROOTT	WIN
BEGO	DENTEM	IDO IMPLANTS	MPI	SEWON MEDIX	XIVE
BIOCONCEPT	DENTIS	IHDE DENTAL (IMBIODENT)	NEOBIOTECH	SIC INVENT	YES IMPLANT
BIOGENESIS	DENTIUM	IMPLANT DIRECT	NEODENT	SIGNO VINCES	ZIACOM
BIOHORIZONS	DIO IMPLANTS	IMPLANT GENESIS	NEOSS	SIN IMPLANTS	ZIMMER
BIOLOK	DITRON	IMPLANTSWISS	NOBEL BIOCARE	SOUTHERN IMPLANTS	
BIOMET 3i	DMI DENTAL SUPPLY	INTRA-LOCK	NORIS MEDICAL	STERI-OSS	
BIONER	DSP BIOMEDICAL		NORMON	STERNGOLD	

COMPATIBILITIES AVAILABLE

AB

Model: I2
Implant Ø: 3.5/3.75/4.2/4.5/
Platform: Standard
Code: 0040

Model: I2
Implant Ø: 5/6
Platform: Standard
Code: 0040

Model: I22
Implant Ø: 3.75/4.22
Platform: Standard
Code: 0040

Model: I5
Implant Ø: 3.5/3.75/4.2/4.5/
Platform: Standard
Code: 0040

Model: I5
Implant Ø: 5/6/7/8
Platform: Standard
Code: 0040

Model: I55
Implant Ø: 3.75/4.2/4.5
Platform: Standard
Code: 0040

Model: I55
Implant Ø: 5/6/7/8
Platform: Standard
Code: 0040

Model: I10
Implant Ø: 4.2/5
Platform: Standard
Code: 0040

Model: I15
Implant Ø: 6/7/8
Platform: Standard
Code: 0040

Model: Multi Unit D1-P64
Implant Ø: Multi Unit D1-P64
Platform: Universal
Code: 0025

ACE

Model: External Hex
Implant Ø: 3.3
Platform: NP 3.5
Code: 0023

Model: External Hex
Implant Ø: 3.75/4
Platform: RP 4.1
Code: 0024

Model: External Hex
Implant Ø: 4.75
Platform: WP 5
Code: 0058

Model: Infinity TRI-CAM
Implant Ø: 3.5
Platform: 3.5
Code: 0026

Model: Infinity TRI-CAM
Implant Ø: 4.3
Platform: 4.3
Code: 0027

Model: Infinity TRI-CAM
Implant Ø: 5
Platform: 5
Code: 0028

Model: Infinity Internal Hex
Implant Ø: 3.7/4.1
Platform: 3.5
Code: 0040

Model: Infinity Internal Hex
Implant Ø: 4.7/5.1
Platform: 4.5
Code: 0041

Model: Infinity Octagon
Implant Ø: 3.3
Platform: RP 4.8
Code: 0037

Model: Infinity Octagon
Implant Ø: 4.1
Platform: RP 4.8
Code: 0037

Model: Infinity Octagon
Implant Ø: 4.8
Platform: RP 4.8
Code: 0037

Model: Infinity Octagon
Implant Ø: 4.8
Platform: WP 6.5
Code: 0096

Model: Multi Unit
Implant Ø: Universal
Platform: Universal
Code: 0025

ADIN

Model: Swell
Implant Ø: 3.3
Platform: 3.45
Code: 0040

Model: Swell
Implant Ø: 3.3
Platform: 3.45
Code: 0042

Model: Swell
Implant Ø: 3.75/4.2
Platform: 3.6
Code: 0040

Model: Swell
Implant Ø: 3.75/4.2
Platform: 3.6
Code: 0042

Model: Swell
Implant Ø: 5
Platform: 4
Code: 0040

Model: Swell
Implant Ø: 5
Platform: 4
Code: 0042

Model: Swell
Implant Ø: 6
Platform: 4.6
Code: 0040

Model: Swell
Implant Ø: 6
Platform: 4.6
Code: 0042

Model: Touareg-S / Touareg-OS
Implant Ø: 3.5
Platform: 3.45
Code: 0040

Model: Touareg-S / Touareg-OS
Implant Ø: 3.5
Platform: 3.45
Code: 0042

Model: Touareg-S / Touareg-OS
Implant Ø: 3.75/4.2
Platform: 3.6
Code: 0040

Model: Touareg-S / Touareg-OS
Implant Ø: 3.75/4.2
Platform: 3.6
Code: 0042

Model: Touareg-S / Touareg-OS
Implant Ø: 5
Platform: 4
Code: 0040

Model: Touareg-S / Touareg-OS
Implant Ø: 5
Platform: 4
Code: 0042

Model: Touareg-S / Touareg-OS
Implant Ø: 6
Platform: 5
Code: 0040

Model: Touareg-S / Touareg-OS
Implant Ø: 6
Platform: 5
Code: 0042

Model: Touareg CloseFit
Implant Ø: 2.75
Platform: UNP
Code: 0188

Model: Touareg CloseFit
Implant Ø: 3
Platform: NP
Code: 0145

Model: Touareg CloseFit
Implant Ø: 3.5
Platform: RP
Code: 0021

Model: Touareg CloseFit
Implant Ø: 4.3/5
Platform: WP
Code: 0022

Model: Triple
Implant Ø: 3.5/3.75/4.2/5/6
Platform: Standard
Code: 0040

Model: Triple
Implant Ø: 3.5/3.75/4.2/5/6
Platform: Standard
Code: 0042

Model: Multi Unit TMA
Implant Ø: Universal
Platform: Universal
Code: 0025

ALFA-GATE

Model: Bioactive/Porous/Trio/MAX
Implant Ø: 3.3/3.75/4.2/4.7/5.2/6
Platform: SP
Code: 0040

Model: Conical
Implant Ø: 3.5
Platform: NP
Code: 0021

Model: Conical
Implant Ø: 4.3/5
Platform: RP
Code: 0022

ALPHABIO

Model: Internal Hex Connection (IH) SPI
Implant Ø: 3.3/3.75/4.2/5/6
Platform: Universal
Code: 0040

Model: Internal Hex Connection (IH) SPI
Implant Ø: 3.7/3.75/4.2/4.65/5.3
Platform: Universal
Code: 0040

Model: Internal Hex Connection (IH) ICE
Implant Ø: 3.3/3.75/4.2/5
Platform: Universal
Code: 0040

Model: Internal Hex Connection (IH) ICE
Implant Ø: 3.3/3.75/4.2/5/6
Platform: Universal
Code: 0040

Model: Internal Hex Connection (IH) DFI
Implant Ø: 3.75/4.2/5
Platform: 3.5
Code: 0040

Model: Conical Hex Connection (CHC)
NICE
Implant Ø: 3.2
Platform: Narrow

Model: Conical Hex Connection (CHC)
NICE
Implant Ø: 3.2/3.5
Platform: Narrow

Model: Conical Standard Connection
(CS)
Implant Ø: 3.75/4.2/5
Platform: Standard

Model: Multi Unit
Implant Ø:
Platform: Universal
Code: 0195

COMPATIBILITIES AVAILABLE

ALPHA-DENT

Model: Classic Conus
Implant Ø: 3.25/3.75
Platform: 3
Code: 0265

Model: Active Conus
Implant Ø: 3.25/3.75
Platform: 3
Code: 0265

ANCLADEN

Model: Anclalock
Implant Ø: 3.75/4.25/5
Platform: 3.5
Code: 0040

ANKYLOS

Model: Ankylos
Implant Ø: 3.5
Platform: 3.5
Code: 0075

Model: Ankylos
Implant Ø: 4.5
Platform: 4.5
Code: 0075

Model: Ankylos
Implant Ø: 5.5
Platform: 5.5
Code: 0075

Model: Ankylos
Implant Ø: 7
Platform: 7
Code: 0075

Model: Balance Base Narrow
Implant Ø: Universal
Platform: Universal
Code: 0183

ANTHOGRYR

Model: Axiom BL REG / PX
Implant Ø: 3.4
Platform: 3.4
Code: 0161

Model: Axiom BL REG / PX
Implant Ø: 4
Platform: 4
Code: 0149

Model: Axiom BL REG / PX
Implant Ø: 4.6
Platform: 4.6
Code: 0149

Model: Axiom BL REG / PX
Implant Ø: 5.2
Platform: 5.2
Code: 0162

Model: Anthofit HE
Implant Ø: 3.5/3.75/4
Platform: R (4,1)
Code: 0024

Model: Anthofit HE
Implant Ø: 5
Platform: L (5)
Code: 0058

Model: Ossfit
Implant Ø: 3.5/4.2
Platform: 4.8
Code: 0074

Model: Ossfit
Implant Ø: 3.5/4.2
Platform: 4.8
Code: 0037

Model: Ossfit
Implant Ø: 5
Platform: 6.5
Code: 0096

Model: Multi Unit
Implant Ø: 4.8
Platform: Universal
Code: 0163

ARDS

Model: Smart
Implant Ø: 3.75/4.2/4.5
Platform: 3.75
Code: 0040

Model: Classic
Implant Ø: 3.3/3.75/4.2/5/6
Platform: 3.75
Code: 0040

Model: Premium
Implant Ø: 3.3/3.75/4.2/5/6
Platform: 3.75
Code: 0040

Model: CIT
Implant Ø: 3.3/3.75/4.2/5/6
Platform: 3.75
Code: 0040

ASTRA

Model: Yellow
Implant Ø: 3
Platform: Yellow (X-estrecha)
Code: 0109

Model: Aqua
Implant Ø: 3.5/4
Platform: Aqua(Estrecha)
Code: 0004

Model: Lilac
Implant Ø: 4.5/5
Platform: Lilac (Ancha)
Code: 0005

Model: Uniabutment Cono 200
Implant Ø: Regular/Wide
Platform: Regular/Wide
Code: 0066

Model: Evolution (Interno)
Implant Ø: 3
Platform: 3
Code: 0090

Model: Evolution (Interno)
Implant Ø: 3.6
Platform: 3.6
Code: 0006

Model: Evolution (Interno)
Implant Ø: 4.2
Platform: 4.2
Code: 0007

Model: Evolution (Interno)
Implant Ø: 4.8
Platform: 4.8
Code: 0091

Model: Evolution (Interno)
Implant Ø: 5.4
Platform: 5.4
Code: 0092

Model: Evolution
(Cono externo 33°)
Implant Ø:
Platform: Universal
Code: 0008

Model: Multibase Abutment
(SmartFix concept)
Implant Ø:
Platform: Universal
Code: 0258

AVINENT

Model: HE/EC
Implant Ø: 3.3//3.5/4
Platform: 3.5
Code: 0023

Model: HE/EC
Implant Ø:
3.3/3.8/4/4.2/4.8//4.5/5
Platform: 4.1
Code: 0024

Model: HE/EC
Implant Ø: 4.8
Platform: 5.1
Code: 0061

Model: HI/IC
Implant Ø: 3.1//3.5/4
Platform: 3.5
Code: 0040_B

Model: HI/IC
Implant Ø:
3.3/3.8/4/4.2/4.8//4.5/5
Platform: 4.1
Code: 0040_B

Model: Transepitelial
Implant Ø:
Platform: Regular
Code: 0025

B&W

Model: Hexágono Externo
Implant Ø: 3.75/4
Platform: 4.1
Code: 0024

Model: Hexágono Externo
Implant Ø: 5
Platform: 5
Code: 0058

Model: Cónico Hexagono
Interno CIH
Implant Ø: 3.3/4
Platform: 4
Code: 0040

Model: Cónico Hexagono
Interno CIH
Implant Ø: 3.3/4
Platform: 4
Code: 0042

BEGO

Model: RS/RSX
Implant Ø: 3.0
Platform: 3.0
Code: 0049

Model: S/RI/RS/RSX
Implant Ø: 3.25/3.75
Platform: 3.67
Code: 0050

Model: S/RI/RS/RSX
Implant Ø: 4.1
Platform: 4.1
Code: 0051

Model: S/RI/RS/RSX
Implant Ø: 4.5
Platform: 4.5
Code: 0052

Model: S/RI/RS/RSX
Implant Ø: 5.5
Platform: 5.5
Code: 0081

Model: Mini
Implant Ø: 2.7/2.9/3.1
Platform: Mini
Code: 0187

Model: MultiPlus
Implant Ø:
Platform: Universal
Code: 0150

BIOCONCEPT

Model: BC Tissue Level Standard
Implant Ø: 3.3/4.1/4.8
Platform: Regular
Code: 0037

Model: BC Tissue Level Standard Plus
Implant Ø: 4.8
Platform: Regular
Code: 0037

Model: BC Tissue Level Tapered Effect
Implant Ø: 4.8
Platform: Regular
Code: 0037

Model: BC Bone Level
Implant Ø: 3.3
Platform: Narrow
Code: 0033

COMPATIBILITIES AVAILABLE

Model: BC Bone Level
Implant Ø: 4.1/4.8
Platform: Regular
Code: 0035

Model: BV Tapered Bone Level
Implant Ø: 3.5
Platform: Narrow
Code: 0029

Model: BV Tapered Bone Level
Implant Ø: 4.1/4.5/5
Platform: Regular
Code: 0030

BIOGENESIS

Model: 3icon
Implant Ø: 3.3
Platform: Mini (Pink)
Code: 0023

Model: 3icon
Implant Ø: 3.75/4/4.3/4.5
Platform: Regular (Blue)
Code: 0024

Model: 3icon
Implant Ø: 5/5.5
Platform: Wide (Yellow)
Code: 0058

Model: Aticon
Implant Ø: 3.5/4/4.5/5
Platform: Blue
Code: 0005

Model: Iticon
Implant Ø: 3.75/4.1/4.8
Platform: 4.8
Code: 0037

BIOHORIZONS

Model: External
Implant Ø: 3.5
Platform: 3.7 (Yellow)
Code: 0023

Model: Tapered Internal
Implant Ø: 3/3.4
Platform: 3 (Grey)
Code: 0102

Model: Tapered Internal
Implant Ø: 3.8
Platform: 3.5 (Yellow)
Code: 0040

Model: Tapered Internal
Implant Ø: 4.6
Platform: 4.5 (Green)
Code: 0041

Model: Tapered Internal
Implant Ø: 5.8
Platform: 5.7 (Blue)
Code: 0080

Model: Tapered Plus
Implant Ø: 3.8
Platform: 3 (Grey)
Code: 0102

Model: Tapered Plus
Implant Ø: 4.6
Platform: 3.5 (Yellow)
Code: 0040

Model: Tapered Plus
Implant Ø: 5.8
Platform: 4.5 (Green)
Code: 0041

Model: Mount-free
Tapered Internal
Implant Ø: 3/3.4
Platform: 3 (Grey)
Code: 0102

Model: Mount-free
Tapered Internal
Implant Ø: 3.8
Platform: 3.5 (Yellow)
Code: 0040

Model: Mount-free
Tapered Internal
Implant Ø: 4.6
Platform: 4.5 (Green)
Code: 0041

Model: Mount-free
Tapered Internal
Implant Ø: 5.8
Platform: 5.7 (Blue)
Code: 0080

Model: Tapered Pro
Implant Ø: 3.8
Platform: 3 (Grey)
Code: 0102

Model: Tapered Pro
Implant Ø: 4.2/4.6
Platform: 3.5 (Yellow)
Code: 0040

Model: Tapered Pro
Implant Ø: 5.2
Platform: 4.5 (Green)
Code: 0041

Model: Tapered Short
Implant Ø: 4.6
Platform: 3.5 (Yellow)
Code: 0040

Model: Tapered Short
Implant Ø: 5.8
Platform: 4.5 (Green)
Code: 0041

Model: Tapered PTG
Implant Ø: 4.2
Platform: 3.5 (Yellow)
Code: 0040

Model: Tapered IM
(Immediate Molar)
Implant Ø: 7/8
Platform: 5.7 (Blue)
Code: 0080

Model: Tapered Tissue Level
Implant Ø: 3/3.8
Platform: 3.5 (Yellow)
Code: 0040

Model: Tapered Tissue Level
Implant Ø: 4.6
Platform: 4.5 (Green)
Code: 0041

Model: Tapered Tissue Level
Implant Ø: 5.8
Platform: 5.7 (Blue)
Code: 0080

Model: Multi Unit
Implant Ø:
Platform: Universal
Code: 0025

BIOLOK

Model: Hexágono Externo
Implant Ø: 3.45
Platform: 3.45
Code: 0003

BIOMET 3I

Model: Osseotite External Hex
Implant Ø: 3.25
Platform: 3.4
Code: 0003

Model: Osseotite External Hex
Implant Ø: 3.75/4
Platform: 4.1
Code: 0024

Model: Osseotite External Hex
Implant Ø: 5
Platform: 5
Code: 0058

Model: Certain
Implant Ø: 3.25/4
Platform: 3.4
Code: 0001

Model: Certain
Implant Ø: 4/5
Platform: 4.1
Code: 0002

Model: Certain
Implant Ø: 5
Platform: 5
Code: 0057

Model: Low Profile
Implant Ø: 5
Platform: Universal
Code: 0025

BIONER

Model: Ikelt / Bikelt
Implant Ø: 3.3/3.75/4
Platform: 4.1
Code: 0024

Model: Ikelt
Implant Ø: 5
Platform: 5
Code: 0058

Model: Hikelt
Implant Ø: 3.8
Platform: 3.95
Code: 0040

Model: Hikelt
Implant Ø: 4.7
Platform: 4.9
Code: 0041

Model: TopDM
Implant Ø: 3.5
Platform: 3.5
Code: 0021

Model: TopDM
Implant Ø: 4
Platform: 4
Code: 0021

Model: TopDM
Implant Ø: 5
Platform: 5
Code: 0021

Model: Short DM
Implant Ø: 4/5/6
Platform: Universal
Code: 0021

Model: Hibikelt
Implant Ø: 4/5
Platform: Universal
Code: 0021

Model: Transeptelial A-5M
Implant Ø: Transeptelial A-5M
Platform: Regular
Code: 0025

BIOTEC

Model: SPR/CIM
Implant Ø: 3.3
Platform: 3.3
Code: 0040

Model: SPR/CIM
Implant Ø: 3.75
Platform: 3.75
Code: 0040

Model: SPR/SPTT/CIM
Implant Ø: 4.2
Platform: 4.2
Code: 0040

Model: SPR/SPTT/CIM
Implant Ø: 5
Platform: 5
Code: 0040

BIOTEM

Model: AR Fixture
Implant Ø: 3.7/4/4.5
Platform: Regular
Code: 0030

COMPATIBILITIES AVAILABLE

BREIDENT MEDICAL

Model: Narrow Sky
Implant Ø: 3,5
Platform: NP 3,5
Code: 0110

Model: Blue Sky
Implant Ø: 3,5/4/4,5/5,5
Platform: 4
Code: 0111

Model: Blue Sky Classic
Implant Ø: 3,5/4/4,5
Platform: 4
Code: 0111

Model: Copa Sky
Implant Ø: 3,5/4/4,5/5/6
Platform: 3,3
Code: 0251

BTI

Model: Externa Tiny
Implant Ø: 2,5/3/3,3/3,5/3,75
Platform: Tiny 3,5
Code: 0009

Model: Externa Universal
Implant Ø: 3,75/4
Platform: Universal 4,1
Code: 0024

Model: Externa Universal Plus
Implant Ø: 4,5/5
Platform: Universal Plus 4,1
Code: 0024

Model: Externa
Implant Ø: 4,5/5/5,5
Platform: Ancha 5,5
Code: 0060

Model: Interna
Implant Ø: 3,3/3,5/3,75
Platform: 3,5
Code: 0257

Model: Interna Universal
Implant Ø: 3,3/3,5/3,75/4/4,25
Platform: Universal 4,1
Code: 0010

Model: Interna Universal Plus
Implant Ø: 4,5/5/5,5
Platform: Universal Plus 4,1
Code: 0010

Model: Interna Ancha
Implant Ø: 5,5/6/6,25
Platform: Ancha 5,5
Code: 0059

Model: Multi-IM
Implant Ø: converter 4,1
Platform: Universal 4,1
Code: 0151

Model: Multi-IM
Implant Ø: converter 5,5
Platform: Ancha 5,5
Code: 0177

BTK

Model: Klassic / Konic
Implant Ø: 3,25
Platform: 3,4 EN
Code: 0003

Model: Klassic / Konic/Line Plus
Implant Ø: 3,25PL/3,75/4
Platform: 4,1 ER
Code: 0024

Model: IS +/-Line Plus IS+
Implant Ø: 3,3/3,7/4,1/4,8/6
Platform: DR
Code: 0029

Model: Klassic / Konic
Implant Ø: 3,3/3,7/4,1/4,8
Platform: KR
Code: 0029

Model: Klassic / Konic
Implant Ø: 3,25/4
Platform: 3,5 IR
Code: 0040

Model: Klassic / Konic
Implant Ø: 3,25/4
Platform: 3,5 IR
Code: 0042

Model: Line Plus IC+
Implant Ø: 3,25/3,75/4,25/5
Platform: LR
Code: 0040

CAMLOG

Model: Camlog Screw-Line/
Progressive-Line
Implant Ø: 3,3
Platform: 3,3
Code: 0087

Model: Camlog Screw-Line/
Progressive-Line
Implant Ø: 3,8
Platform: 3,8
Code: 0011

Model: Camlog Screw-Line/
Progressive-Line
Implant Ø: 4,3
Platform: 4,3
Code: 0012

Model: Camlog Screw-Line/
Progressive-Line
Implant Ø: 5
Platform: 5
Code: 0088

Model: Conelog Screw-Line/
Progressive-Line
Implant Ø: 3,3
Platform: 3,3
Code: 0119

Model: Conelog Screw-Line/
Progressive-Line
Implant Ø: 3,8
Platform: 3,8
Code: 0120

Model: Conelog Screw-Line/
Progressive-Line
Implant Ø: 4,3
Platform: 4,3
Code: 0121

CONEXÃO SISTEMA DE PRÓTESE

Model: Flash
Implant Ø: 3,5/4,3/5
Platform: Universal
Code: 0021

Model: Torq
Implant Ø: 3,5/3,75/4
Platform: Universal
Code: 0021

Model: Expand
Implant Ø: 3,75/4/5
Platform: Universal
Code: 0021

CORTEX

Model: Internal Hex Dynamix
Implant Ø: 3,3/3,8/4,2/5/6
Platform: 3,75
Code: 0040

Model: Internal Hex Classix
Implant Ø: 3,3/3,8/4,2/5/6
Platform: 3,75
Code: 0040

Model: Internal Hex Saturn
Implant Ø: 3,8/4,2
Platform: 3,5
Code: 0040

Model: Conical Dynamix
Implant Ø: 3
Platform: NP
Code: 0109

Model: Conical Dynamix
Implant Ø: 3,3/3,8/4,2
Platform: RP
Code: 0004

Model: Conical Dynamix
Implant Ø: 5/6
Platform: WP
Code: 0005

Model: Conical Classix
Implant Ø: 3,3/3,8/4,2
Platform: RP
Code: 0004

Model: Conical Classix
Implant Ø: 5/6
Platform: WP
Code: 0005

Model: Conical Magix
Implant Ø: 3,3/3,8/4,2
Platform: RP
Code: 0004

Model: Multi Unit
Implant Ø:
Platform: Universal
Code: 0025

COWELLMEDI

Model: Inno - External Type
Implant Ø: 5,0/6,0
Platform: 5,1
Code: 0061

Model: Multi S&A
Abutment Ø 4,5 mm
Implant Ø: Multi S Abutment
Platform: Universal
Code: 0193

C-TECH

Model: EL Esthetic Line
Implant Ø: 3,8/4,3/5,1
Platform: 4
Code: 0246

Model: Multi Unit
Implant Ø:
Platform: Universal
Code: 0245

DENTAL TECH

Model: Implologic
Implant Ø: 4,5
Platform: 4,5 (Blue)
Code: 0041

DENTAURUM

Model: Tiologic
Implant Ø: 3,3
Platform: Small
Code: 0130

Model: Tiologic
Implant Ø: 3,7/4,2
Platform: Medium
Code: 0131

Model: Tiologic
Implant Ø: 4,8/5,5
Platform: Large
Code: 0132

COMPATIBILITIES AVAILABLE

DENTEGRIS

Model: SLS-Straight
Implant Ø: 4.5
Platform: 4.5
Code: 0041_B

Model: Sinus-Lift
Implant Ø: 4.5
Platform: 4.5
Code: 0041_B

Model: S&T Implants
Implant Ø: 4.5
Platform: 4.5
Code: 0041_B

DENTEM

Model: Regular
Implant Ø:
Platform: Regular
Code: 0030

DENTIS

Model: OneQ-SL
Implant Ø: 3
Platform: Narrow
Code: 0014

Model: OneQ-SL
Implant Ø: 3.9/4.2/4.7/5.2
Platform: Regular
Code: 0030

Model: OneQ-SL
Implant Ø: 6/7/8
Platform: Wide
Code: 0030

Model: s-Clean Tapered /
Tapered II
Implant Ø: 3.7
Platform: Mini
Code: 0030

Model: s-Clean Tapered /
Tapered II
Implant Ø: 4.1/4.3
Platform: Regular
Code: 0030

Model: s-Clean Tapered /
Tapered II
Implant Ø: 4.8
Platform: Wide
Code: 0030

Model: s-Clean Straight
Implant Ø: 4.1/4.8
Platform: 4.1/4.8
Code: 0030

Model: s-Clean Save
Implant Ø: 5.5/6
Platform: 5.5/6
Code: 0030

Model: SQ-SL
Implant Ø: 3.5
Platform: Narrow
Code: 0014

Model: SQ-SL
Implant Ø: 4/4.5/5
Platform: Regular
Code: 0030

Model: SQ-SL
Implant Ø: 6/7/8
Platform: Wide
Code: 0030

Model: e-Clean
Implant Ø: 3.5
Platform: Mini
Code: 0023

Model: e-Clean
Implant Ø: 4.1
Platform: Regular
Code: 0024

Model: e-Clean
Implant Ø: 5.1
Platform: Wide
Code: 0061

Model: i-Clean Tapered
Implant Ø: 3.7
Platform: Mini
Code: 0037

Model: i-Clean Tapered
Implant Ø: 4.1/4.3
Platform: Regular
Code: 0037

Model: i-Clean Tapered
Implant Ø: 4.8
Platform: Wide
Code: 0037

Model: i-Clean Straight
Implant Ø: 4.1/4.8
Platform: 4.8
Code: 0037

Model: Octa Abutment
Implant Ø: Universal
Platform: Universal
Code: 0074

DENTIUM

Model: NR Line
Implant Ø: 3.1
Platform: 3.2
Code: 0190

Model: NR Line
Implant Ø: 3.1
Platform: 3.6
Code: 0190

Model: NR Line
Implant Ø: 3.6
Platform: 3.6
Code: 0191

Model: NR Line
Implant Ø: 4.3
Platform: 4.3
Code: 0191

Model: NR Line
Implant Ø: 5
Platform: 5
Code: 0191

Model: NR Line
Implant Ø: 6
Platform: 6
Code: 0191

Model: Multi Unit NR Line
Implant Ø:
Platform: 5
Code: 0192

Model: SimpleLine II
Implant Ø: 3.8/4.3
Platform: 4.8
Code: 0074

Model: SimpleLine II
Implant Ø: 3.8/4.3
Platform: 4.8
Code: 0037

Model: SimpleLine II
Implant Ø: 4.3/4.8
Platform: 6.5
Code: 0096

Model: SuperLine/SuperLine II/
Implantium
Implant Ø: 3.4
Platform: 3.6
Code: 0030

Model: SuperLine/SuperLine II/
Implantium
Implant Ø: 3.8
Platform: 4
Code: 0030

Model: SuperLine/SuperLine II/
Implantium
Implant Ø: 4.3
Platform: 4.5
Code: 0030

Model: SuperLine/SuperLine II/
Implantium
Implant Ø: 4.8
Platform: 5
Code: 0030

Model: SuperLine/SuperLine II/
Implantium
Implant Ø: 4.8
Platform: 6
Code: 0030

Model: Multi Unit Superline and
Implantium
Implant Ø:
Platform: 4.5
Code: 0193

DIO IMPLANTS

Model: SM System
Implant Ø: 4.5/5/5.3
Platform: Regular/Wide
Code: 0013

Model: UF II Narrow
Implant Ø: 3/3.3
Platform: Narrow
Code: 0014

Model: UF II
Implant Ø: 3.8/4/4.5/5/5.5
Platform: Regular
Code: 0030

Model: External
Implant Ø: 3.3/3.8
Platform: Narrow 3.5
Code: 0023

Model: External
Implant Ø: 3.75/4/4.5
Platform: Regular 4.1
Code: 0024

Model: External
Implant Ø: 5/5.3/5.5/6
Platform: Wide 5.1
Code: 0061

Model: Internal OCTA
Implant Ø:
Platform: 4.8
Code: 0074

Model: Multi Unit
Implant Ø:
Platform: Universal
Code: 0247

DITRON

Model: Ultimate Matrix
Implant Ø: 3.75/4.2
Platform: 3.75
Code: 0040

Model: Ultimate Matrix
Implant Ø: 5
Platform: 4
Code: 0040

Model: Ultimate Matrix
Implant Ø: 6
Platform: 4.6
Code: 0040

Model: MPI Matrix
Implant Ø: 3.5
Platform: 3.5
Code: 0040

Model: MPI Matrix
Implant Ø: 3.75
Platform: 3.75
Code: 0040

Model: MPI Matrix
Implant Ø: 4.2
Platform: 4.2
Code: 0040

Model: MPI Matrix
Implant Ø: 5
Platform: 5
Code: 0040

Model: MPI Matrix
Implant Ø: 6
Platform: 6
Code: 0040

DMI DENTAL SUPPLY

Model: DCI/DSI
Implant Ø: 3.3/3.5/3.75/4.2/5/6
Platform: 3.75
Code: 0040

COMPATIBILITIES AVAILABLE

DSP BIOMEDICAL

Model: Hexágono Externo
Implant Ø: 3,75/4/5//3,5/3,8/4,3
Platform: 4.1
Code: 0024

EASY IMPLANT

Model: Master C
Implant Ø: 3.5
Platform: 3.5 (Ocean)
Code: 0004

Model: Master C
Implant Ø: 4
Platform: 4 (Ocean)
Code: 0004

Model: Master C
Implant Ø: 4.5
Platform: 4.5 (Lilas)
Code: 0030

Model: Master C
Implant Ø: 5
Platform: 5 (Lilas)
Code: 0030

Model: Master S
Implant Ø: 3.3
Platform: 3.3 (Ocean)
Code: 0004

Model: Master S
Implant Ø: 3.75
Platform: 3.75 (Lilas)
Code: 0030

Model: Master S
Implant Ø: 4.25
Platform: 4.25 (Lilas)
Code: 0030

Model: Master S
Implant Ø: 4.75
Platform: 4.75 (Lilas)
Code: 0030

Model: Master L
Implant Ø: 3.3
Platform: 3.3 (Lilas)
Code: 0030

Model: Master L
Implant Ø: 3.75
Platform: 3.75 (Lilas)
Code: 0030

Model: Master L
Implant Ø: 4.25
Platform: 4.25 (Lilas)
Code: 0030

Model: Master L
Implant Ø: 4.75
Platform: 4.75 (Lilas)
Code: 0030

Model: MINI
Implant Ø: 3
Platform: 3
Code: 0176

Model: Hexcel-S
Implant Ø: 3.3
Platform: 3.3
Code: 0003

Model: Hexcel-S
Implant Ø: 3.75
Platform: 4.1
Code: 0024

Model: Hexcel-S
Implant Ø: 4.25
Platform: 4.1
Code: 0024

Model: Hexcel-S
Implant Ø: 4.75
Platform: 5
Code: 0058

Model: Multi Unit Conical
Abutment
Implant Ø:
Platform: Universal
Code: 0025

ECKERMANN

Model: All-Spiral
Implant Ø: 4
Platform: Regular
Code: 0069

Model: Duplo
Implant Ø: 4
Platform: Regular
Code: 0070

Model: Hexagon
Implant Ø: 3/3.5/4/4.5/5
Platform: 4.1
Code: 0024

Model: Winner
Implant Ø: 3/3.5/4
Platform: 3.5
Code: 0040_B

Model: Winner
Implant Ø: 3/3.5/4
Platform: 3.5
Code: 0042

Model: Winner
Implant Ø: 4/4.5/5
Platform: 4.5
Code: 0041_B

Model: Winner
Implant Ø: 4/4.5/5
Platform: 4.5
Code: 0043

ELITE MEDICA

Model: Conexión Externa
Implant Ø: 3.75
Platform: Narrow
Code: 0023

Model: Conexión Externa
Implant Ø: 4
Platform: Regular
Code: 0024

Model: Conexión Externa
Implant Ø: 5
Platform: Wide
Code: 0061

EUROTEKNIKA

Model: Naturactis
Implant Ø: 3.5
Platform: 3.4
Code: 0004

Model: Naturactis
Implant Ø: 4
Platform: 3.8
Code: 0004

Model: Naturactis
Implant Ø: 4.5
Platform: 4.3
Code: 0004

Model: Naturactis
Implant Ø: 5
Platform: 4.8
Code: 0004

Model: Uneva
Implant Ø: 3.6
Platform: 4.1
Code: 0024

Model: Uneva
Implant Ø: 4.1
Platform: 4.1
Code: 0024

Model: Uneva
(Platform Switching)
Implant Ø: 4.8
Platform: 4.1
Code: 0024

Model: Uneva
(Platform Switching)
Implant Ø: 6
Platform: 4.1
Code: 0024

Model: Natea
Implant Ø: 3.6/4.1/4.8
Platform: Narrow
Code: 0004

Model: Natea
Implant Ø: 3.6/4.1/4.8
Platform: Regular
Code: 0004

Model: Natea
Implant Ø: 6
Platform: Wide
Code: 0004

Model: Aesthetica
Implant Ø: 4.1
Platform: 4.8
Code: 0074

Model: Aesthetica
Implant Ø: 4.1
Platform: 4.8
Code: 0037

Model: Aesthetica
Implant Ø: 4.8
Platform: 6.5
Code: 0096

Model: Naturall
Implant Ø: 3.5
Platform: Narrow
Code: 0004

Model: Naturall
Implant Ø: 4/4.5
Platform: Regular
Code: 0004

Model: Naturall
Implant Ø: 5
Platform: Wide
Code: 0004

Model: Ibone E/Ibone S
Implant Ø: 3.8/4.3/4.8
Platform: 3.5
Code: 0004

Model: Ibone E/Ibone S
Implant Ø: 4.8/5.5/6.2
Platform: 4.3
Code: 0004

Model: Ibone G
Implant Ø: 4.8/5.5
Platform: RP
Code: 0037

Model: Ibone G
Implant Ø: 5.5/6.2
Platform: WP
Code: 0096

Model: Multi Unit Tetra
Implant Ø: 4.1
Platform: Universal
Code: 0025

F&B IMPLANT (FIT & BRILLANT)

Model: FA Submerged Fixture
Implant Ø: 3.9
Platform: Narrow
Code: 0030

Model: FA Submerged Fixture
Implant Ø: 4.1/4.4
Platform: Regular
Code: 0030

Model: FA Submerged Fixture
Implant Ø: 4.8
Platform: Wide
Code: 0030

Model: FA Submerged Fixture
Implant Ø: 5.3/5.8/6.3/6.8
Platform: Ultra-Wide
Code: 0030

GALIMPLANT

Model: Conexión Externa
Implant Ø: 3.5/4
Platform: 4
Code: 0024

Model: Conexión Interna
Implant Ø: 3.5
Platform: 3.5
Code: 0004

COMPATIBILITIES AVAILABLE

Model: Conexión Interna
Implant Ø: 4
Platform: 4
Code: 0004

Model: Conexión Interna
Implant Ø: 5
Platform: 5
Code: 0004

Model: Pilar multi-posicion recto/
Pilar multi-posicion angulado
Implant Ø: Universal
Platform: Universal
Code: 0025

GC TECH

Model: AADVA Standard /
Tapered Implants
Implant Ø: 3.3
Platform: Narrow
Code: 0196

Model: AADVA Standard /
Tapered Implants
Implant Ø: 4
Platform: Regular
Code: 0197

Model: AADVA Standard /
Tapered Implants
Implant Ø: 5
Platform: Wide
Code: 0198

GMI (ILERIMPLANT)

Model: Phoenix
Implant Ø: 3.3/3.75/4
Platform: Standard 4.1
Code: 0024

Model: Phoenix
Implant Ø: 5
Platform: Wide 5.1
Code: 0061

Model: Frontier
Implant Ø: 3.3/3.75/4.25
Platform: RP 3.3
Code: 0040_B

Model: Frontier
Implant Ø: 4.75/5.75
Platform: WP 4.3
Code: 0041_B

Model: Universal
Implant Ø: Universal
Platform: PS-RP 4.8
Code: 0025

Model: Avantgard
Implant Ø: 3.75/4.25
Platform: RP
Code: 0243

GT MEDICAL

Model: Best Fit Octógono Interno
Implant Ø: 3.7/4.3/4.8
Platform: Regular
Code: 0074

Model: Best Fit Octógono Interno
Implant Ø: 3.7/4.3/4.8
Platform: Regular
Code: 0037

Model: Best Fit Hexágono Interno
Implant Ø: 3.7/4.1/4.3/4.8
Platform: Wide
Code: 0005

Model: Best Fit Hexágono Externo
Implant Ø: 3.5
Platform: Narrow
Code: 0023

Model: Best Fit Hexágono Externo
Implant Ø: 4.1
Platform: Regular
Code: 0024

Model: Best Fit Hexágono Externo
Implant Ø: 5.1
Platform: Wide
Code: 0061

HAHN IMPLANT (GLIDEWELL)

Model: Hahn Tapered Implant
Implant Ø: 3.5/4.3
Platform: 3.5/4.3
Code: 0021

Model: Hahn Tapered Implant
Implant Ø: 5
Platform: 5
Code: 0022

Model: Hahn Tapered Implant
Implant Ø: 7
Platform: 7
Code: 0124

Model: Multi-Unit Abutment system
Implant Ø: Universal
Platform: Universal
Code: 0025

HIOSSEN

Model: ETIII SA / ETIII SA
Implant Ø: 3.5
Platform: Mini
Code: 0029

Model: ETIII SA / ETIII SA / ETIV SA
Implant Ø: 4/4.5/5
Platform: Regular
Code: 0030

Model: ETIII BA
Implant Ø: 3.5
Platform: Mini
Code: 0029

Model: ETIII BA
Implant Ø: 4/4.5/5
Platform: Regular
Code: 0030

HI-TEC

Model: Tapered Self Thread
Implant Ø: 3.3/3.75
Platform: 3.5
Code: 0040

Model: Tapered Self Thread
Implant Ø: 4.2/5
Platform: 4.5
Code: 0041

Model: Logic Plus
Implant Ø: 3.5
Platform: 3.7
Code: 0040

Model: Logic Plus
Implant Ø: 4.3
Platform: 3.9
Code: 0040

IBS

Model: Magic FC
Implant Ø: 4/4.5/5/5.5/6/6.5
Platform: 3.8
Code: 0030

Model: N.R. Fix
Implant Ø: 3/3.5
Platform: 3.8
Code: 0030

IDO IMPLANTS

Model: I Do Implant
Implant Ø: 3.8/4/4.5/5/5.5/6/7
Platform: Universal
Code: 0030

IHDE DENTAL (IMBIODENT)

Model: Bone Level Plus
Implant Ø: 3.3
Platform: 3.3
Code: 0033

Model: Bone Level Plus
Implant Ø: 4.1
Platform: 4.1
Code: 0035

Model: Bone Level Plus
Implant Ø: 4.8
Platform: 4.8
Code: 0035

IMPLANT DIRECT

Model: RePlus / Replant /
Reactive
Implant Ø: 3.5/3.7/4.2
Platform: 3.5
Code: 0026

Model: RePlus / Replant /
Reactive
Implant Ø: 4.3/4.7
Platform: 4.3
Code: 0027

Model: RePlus / Replant /
Reactive
Implant Ø: 5/5.7
Platform: 5
Code: 0028

Model: Legacy
Implant Ø: 3.7/4.2
Platform: 3.5
Code: 0040

Model: Legacy
Implant Ø: 4.7/5.2
Platform: 4.5
Code: 0041

Model: Swishplant / Swishplus
Implant Ø: 4.1/4.8
Platform: 4.8
Code: 0074

Model: Swishplant / Swishplus
Implant Ø: 4.1/4.8
Platform: 4.8
Code: 0037

Model: Swishplant / Swishplus
Implant Ø: 4.8/5.7
Platform: 6.5
Code: 0096

Model: SwishActive
Implant Ø: 3.3
Platform: 3
Code: 0021

Model: SwishActive
Implant Ø: 4.1/4.8
Platform: 3.4
Code: 0022

Model: Interactive
Implant Ø: 3.2/3.7
Platform: 3
Code: 0021

Model: Interactive
Implant Ø: 4.3/5
Platform: 3.4
Code: 0022

Model: Simply Iconic
Implant Ø: 3.2/3.7/4.2
Platform: Purple 3.0
Code: 0021

Model: Simply Iconic
Implant Ø: 4.7/5.2/5.7
Platform: Gold 3.4
Code: 0022

Model: Multi Unit Abutment
Implant Ø:
Platform: 5
Code: 00158

IMPLANT GENESIS

Model: Aktiv System
Implant Ø: 3.5/3.75/4.2/5
Platform: Standard
Code: 0040

IMPLANTSWISS

Model: Bone Level
Implant Ø: 3.3
Platform: 3.3
Code: 0004

Model: Bone Level
Implant Ø: 3.7
Platform: 3.7
Code: 0030

Model: Bone Level
Implant Ø: 4.3
Platform: 4.3
Code: 0030

Model: Bone Level
Implant Ø: 4.8
Platform: 4.8
Code: 0030

COMPATIBILITIES AVAILABLE

Model: Bone Level
Implant Ø: 5.5
Platform: 5.5
Code: 0030

Model: Multi Unit Abutment
Implant Ø: Universal
Platform: 4.8
Code: 0025

INTRA-LOCK

Model: UniHex
Implant Ø: 4
Platform: Regular
Code: 0024

Model: UniHex
Implant Ø: 4.75
Platform: Wide
Code: 0024

Model: IntraHex
Implant Ø: 3.75/4
Platform: 3.5
Code: 0040

Model: IntraHex
Implant Ø: 4.75
Platform: 4.5
Code: 0041

JDENTALCARE

Model: JDEvolution/
JDEvolution Plus
Implant Ø: 3.7
Platform: 3.7
Code: 0040

Model: JDEvolution/
JDEvolution Plus
Implant Ø: 4.3/5
Platform: 4
Code: 0040

Model: JDEvolution/
JDEvolution Plus
Implant Ø: 6
Platform: 5
Code: 0040

Model: JD Pterygo
Implant Ø: 4
Platform: 4
Code: 0040

Model: JD ICON/JD ICON F
Implant Ø: 3.9
Platform: 3.9
Code: 0022

Model: JD ICON/JD ICON F
Implant Ø: 4.3
Platform: 4
Code: 0022

Model: JD ICON/JD ICON F
Implant Ø: 5
Platform: 4.7
Code: 0022

Model: JD ICON Plus
Implant Ø: 3.7
Platform: 3.7
Code: 0015

Model: JD ICON Plus
Implant Ø: 4.3
Platform: 4
Code: 0015

Model: JD ICON Plus
Implant Ø: 5
Platform: 4.8
Code: 0015

Model: JD ICON Plus T
Implant Ø: 3.5
Platform: 3.5
Code: 0015

Model: JD ICON Plus T
Implant Ø: 4
Platform: 3.5
Code: 0015

Model: JD ICON Plus T
Implant Ø: 4.5
Platform: 3.5
Code: 0015

Model: Conical Abutment
Implant Ø:
Platform: Universal
Code: 0025

KEYSTONE

Model: Restore
Implant Ø: 3.75/4
Platform: RD 4.1
Code: 0024

Model: Restore
Implant Ø: 5/6
Platform: WD 5
Code: 0061

Model: Internal TiLobe
PrimaConnex
Implant Ø: 3.3/3.5
Platform: 3.5
Code: 0044

Model: Internal TiLobe
PrimaConnex
Implant Ø: 4/4.1
Platform: 4.1
Code: 0045

Model: Internal TiLobe
PrimaConnex
Implant Ø: 5
Platform: 5
Code: 0046

Model: Internal TiLobe Prima Plus
Implant Ø: 3.5
Platform: 3.5
Code: 0044

Model: Internal TiLobe Prima Plus
Implant Ø: 4.1
Platform: 4.1
Code: 0045

Model: Internal TiLobe Prima Plus
Implant Ø: 5/6
Platform: 5
Code: 0046

KLOCKNER

Model: Essential Cone
Implant Ø: 3.5/4/4.5
Platform: 4.5
Code: 0054

Model: Essential Cone
Implant Ø: 4.8
Platform: 6
Code: 0071

Model: Essential Cone Pilar 25°
Implant Ø: 3.5/4/4.5
Platform: 4.5
Code: 0054

Model: Essential Cone
Octacone 12°
Implant Ø: 3.5/4/4.5
Platform: 4.5
Code: 0054

Model: KL
Implant Ø: 3.3
Platform: Narrow
Code: 0023

Model: KL
Implant Ø: 3.7/4.2
Platform: Regular
Code: 0024

Model: KL
Implant Ø: 4.7
Platform: Wide
Code: 0061

Model: Vega
Implant Ø: 3.5
Platform: NV
Code: 0082

Model: Vega
Implant Ø: 4/4.5
Platform: RV
Code: 0083

Model: Vega+
Implant Ø: 5
Platform: NV
Code: 0082

Model: Vega+
Implant Ø: 4.1/4.6
Platform: RV
Code: 0083

Model: Multi Unit Permanent
Implant Ø: 4.2
Platform: Universal
Code: 0173

KUWOTECH

Model: KISPLANT
Implant Ø: Cono Morse +
Hexágono Interno
Platform: 3.5
Code: 0030

Model: KISPLANT
Implant Ø: Cono Morse +
Hexágono Interno
Platform: 4/4.5/5/5.5/6
Code: 0030

LASAK

Model: Bioniq
Implant Ø: 2.9
Platform: QN (Amarillo)
Code: 0166

Model: Bioniq
Implant Ø: 3.5
Platform: QR (Azul)
Code: 0167

Model: Bioniq
Implant Ø: 4
Platform: QR (Azul)
Code: 0167

Model: Bioniq
Implant Ø: 5
Platform: QR (Azul)
Code: 0167

LEADER

Model: Tixos Internal Hex
Implant Ø: 3.3
Platform: 3.5
Code: 0040

Model: Tixos Internal Hex
Implant Ø: 3.75
Platform: 4
Code: 0040

Model: Tixos External Hex
Implant Ø: 3.3/3.75
Platform: 4.1
Code: 0024

Model: Tixos External Hex
Implant Ø: 5
Platform: 5
Code: 0058

MEDENTIKA

Model: Multi Unit
Implant Ø:
Platform: Universal
Code: 0025

COMPATIBILITIES AVAILABLE

MEDENTIS

Model: Premium/Active Master
Implant Ø: 3.3
Platform: 3.3 (Pink)
Code: 0249

Model: Premium/Active Master
Implant Ø: 3.75
Platform: 3.75 (Red)
Code: 0125

Model: Premium/Active Master
Implant Ø: 4.1
Platform: 4.1 (Green)
Code: 0125

Model: Premium/Active Master
Implant Ø: 4.8
Platform: 4.8 (Blue)
Code: 0125

MEGAGEN

Model: AnyRidge
Implant Ø: 3.5
Platform: Small
Code: 0015

Model: AnyRidge
Implant Ø: 4/4.5
Platform: Regular
Code: 0015

Model: AnyRidge
Implant Ø: 5/5.5
Platform: Wide
Code: 0015

Model: AnyOne Internal
Implant Ø: 3.5/4/4.5/5/6/7
Platform: General
Code: 0030

Model: AnyOne External
Implant Ø: 3.5
Platform: Small 3.5
Code: 0023

Model: AnyOne External
Implant Ø: 4
Platform: Regular 4.1
Code: 0024

Model: AnyOne External
Implant Ø: 4.5
Platform: Regular 4.5
Code: 0024

Model: AnyOne External
Implant Ø: 5
Platform: Wide 5
Code: 0058

Model: AnyOne External
Implant Ø: 6
Platform: SuperWide 5.5
Code: 0058

Model: Cone Abutment
Implant Ø: Universal
Platform: 3.8
Code: 0128

Model: Cone Abutment
Implant Ø: Universal
Platform: 4.8
Code: 0074

Model: Mini Narrow Ridge
Implant Ø: 3/3.4
Platform: Mini
Code: 0014

Model: ExFeel
Implant Ø: 3.5
Platform: Small
Code: 0037

Model: ExFeel
Implant Ø: 4.1
Platform: Regular
Code: 0037

Model: ExFeel
Implant Ø: 4.8/5
Platform: Wide
Code: 0037

Model: Multi Unit N Type
Implant Ø: Multi Unit N Type
Platform: Universal
Code: 0025

Model: Multi Unit S Type
Implant Ø: Multi Unit S Type
Platform: Universal
Code: 0264

MICRODENT

Model: Universal
Implant Ø: 2.8/3.25
Platform: 3.5
Code: 0003

Model: Universal
Implant Ø: 3.3/3.5/3.75/4
Platform: 4.1
Code: 0024

Model: Universal
Implant Ø: 4.2/5
Platform: 5.1
Code: 0058

Model: System
Implant Ø: 2.8/3.25
Platform: 3.5
Code: 0003

Model: Ektos
Implant Ø: 3.7/4.2
Platform: 3.5
Code: 0040_B

MIS

Model: Lance
Implant Ø: 3.75/4.2
Platform: Standard
Code: 0024

Model: Lance
Implant Ø: 5
Platform: Wide
Code: 0058

Model: Multi-Unit
Implant Ø:
Platform: General
Code: 0020

Model: Seven
Implant Ø: 3.3
Platform: Narrow
Code: 0019

Model: Seven
Implant Ø: 3.75/4.2
Platform: Standard
Code: 0040

Model: Seven
Implant Ø: 5/6
Platform: Wide
Code: 0041

Model: M4
Implant Ø: 3.3
Platform: Narrow
Code: 0019

Model: M4
Implant Ø: 3.75/4.2
Platform: Standard
Code: 0040

Model: M4
Implant Ø: 5/6
Platform: Wide
Code: 0041

Model: C1
Implant Ø: 3.3
Platform: Narrow
Code: 0016

Model: C1
Implant Ø: 3.75/4.2
Platform: Standard
Code: 0017

Model: C1
Implant Ø: 5
Platform: Wide
Code: 0018

Model: V3
Implant Ø: 3.9/4.3/5
Platform: Standard
Code: 0017

MONOIMPLANT

Model: MonoImplant Multi Unit
Implant Ø: 3/3.7/4.1
Platform: 4.8
Code: 0025

MOZO-GRAU (TICARE)

Model: MG Osseous
Implant Ø: 3.3
Platform: 3.4 Mini
Code: 0003

Model: MG Osseous
Implant Ø: 3.4/3.75/4.25
Platform: 4.1 Standard
Code: 0024

Model: MG Osseous
Implant Ø: 5
Platform: 5 Maxi
Code: 0061

Model: MG Inhex
Implant Ø: 3.3
Platform: 2.3 Mini
Code: 0109

Model: MG Inhex
Implant Ø: 3.75/4.25
Platform: 2.8 Standard
Code: 0004

Model: MG Inhex
Implant Ø: 5
Platform: 3.8 Maxi
Code: 0005

MPI

Model: Conexión Externa HE
Privilege
Implant Ø: 3.3
Platform: 3.5
Code: 0009

Model: Conexión Externa HE
Privilege
Implant Ø: 3.3/4
Platform: 4.1
Code: 0024

Model: Conexión Externa HE
Privilege
Implant Ø: 5
Platform: 5
Code: 0058

Model: Privilege CM
Implant Ø: 3.5/4
Platform: Regular
Code: 0004

COMPATIBILITIES AVAILABLE

Model: Privilege CM
Implant Ø: 5
Platform: Wide
Code: 0005

Model: Excellence CM
Implant Ø: 3.5/4
Platform: Regular
Code: 0004

Model: Excellence CM
Implant Ø: 5
Platform: Wide
Code: 0005

NEOBIOTECH

Model: EB External System
Implant Ø: 3.5
Platform: Narrow
Code: 0023

Model: IS Implant System
Implant Ø: 3.2
Platform: S-Narrow
Code: 0029

Model: IS Implant System
Implant Ø: 3.5
Platform: Narrow
Code: 0030

Model: IS Implant System
Implant Ø: 4
Platform: Regular
Code: 0030

Model: IS Implant System
Implant Ø: 4.5
Platform: Regular
Code: 0030

Model: IS Implant System
Implant Ø: 5
Platform: Wide
Code: 0030

Model: IS Implant System
Implant Ø:
Platform: 4.8
Code: 0025

NEODENT

Model: Helix GM/Drive GM/
Titamax GM
Implant Ø: 3.5/3.75/4/4.3/5/6
Platform: Regular
Code: 0186

Model: Smart HE
Implant Ø: 3.75/4
Platform: 4.1
Code: 0024

Model: Helix HE
Implant Ø: 3.75/4/4.3
Platform: 4.1
Code: 0024

Model: Mini Pilar CM /
Mini Pilar Angulado CM
Implant Ø: Mini Pilar CM /
Mini Pilar Angulado CM
Platform: Universal
Code: 0025

NEOSS

Model: ProActive Straight/
Tapered/Edge
Implant Ø: 3.5 Green
Platform: Standard
Code: 0047

Model: ProActive Straight/
Tapered/Edge
Implant Ø: 4 Yellow
Platform: Standard
Code: 0047

Model: ProActive Straight/
Tapered/Edge
Implant Ø: 4.5 Blue
Platform: Standard
Code: 0048

Model: ProActive Straight/
Tapered/Edge
Implant Ø: 5 Peach
Platform: Standard
Code: 0048

Model: ProActive Straight/
Tapered/Edge
Implant Ø: 5.5 Lilac
Platform: Standard
Code: 0048

Model: ProActive Wide
Implant Ø: 6
Platform: Standard
Code: 0048

Model: ProActive Sinus
Implant Ø: 6.5
Platform: Standard
Code: 0048

Model: Short Implant
Implant Ø: 3.5/4/4.5
Platform: Standard
Code: 0047

Model: Short Implant
Implant Ø: 5/5.5/6/6.5
Platform: Standard
Code: 0048

NOBEL BIOCARE

Model: Branemark
Implant Ø: 3.3
Platform: Narrow
Code: 0023

Model: Branemark
Implant Ø: 3.75/4
Platform: Regular
Code: 0024

Model: Branemark
Implant Ø: 5/6
Platform: Wide
Code: 0061

Model: Multi-Unit
Implant Ø: Regular
Platform: Regular
Code: 0025

Model: Standard
Implant Ø:
Platform: Regular
Code: 0077

Model: Replace
Implant Ø: 3.5
Platform: Narrow
Code: 0026

Model: Replace
Implant Ø: 4.3
Platform: Regular
Code: 0027

Model: Replace
Implant Ø: 5
Platform: Wide
Code: 0028

Model: Replace
Implant Ø: 6
Platform: Platform 6
Code: 0129

Model: Active/Replace
Conical Connection
Implant Ø: 3
Platform: Mini 3.0
Code: 0159

Model: Active/Replace
Conical Connection
Implant Ø: 3.5
Platform: Narrow
Code: 0021

Model: Active/Replace
Conical Connection
Implant Ø: 4.3/5
Platform: Regular
Code: 0022

Model: Active/Replace
Conical Connection
Implant Ø: 5.5
Platform: Wide
Code: 0124

Model: NobelSpeedy
Implant Ø: 3.3
Platform: Narrow
Code: 0023

Model: NobelSpeedy
Implant Ø: 4/5
Platform: Regular
Code: 0024

Model: NobelSpeedy
Implant Ø: 5/6
Platform: Wide
Code: 0061

Model: NobelParallel
Implant Ø: 3.75
Platform: Narrow
Code: 0021

Model: NobelParallel
Implant Ø: 4.3/5
Platform: Regular
Code: 0022

Model: NobelParallel
Implant Ø: 5.5
Platform: Wide
Code: 0124

NORIS MEDICAL

Model: Tuff
Implant Ø: 3.3/3.75/4.2/5/6
Platform: 3.75
Code: 0040

Model: Tuff TT
Implant Ø: 3.3/3.75/4.2/5/6
Platform: 3.75
Code: 0040

Model: Onix
Implant Ø: 3.3/3.75/4.2/5/6
Platform: 3.75
Code: 0040

Model: Cortical
Implant Ø: 4.0/5/6
Platform: 3.75
Code: 0040

Model: PteryCore
Implant Ø: 4.2
Platform: 3.75
Code: 0040

Model: PteryFit
Implant Ø: 4.2
Platform: 3.75
Code: 0040

NORMON

Model: Normoimplant HE
Implant Ø: 3.25/3.75/4.25/4.75
Platform: 4.1
Code: 0024

Model: Normoimplant HI
Implant Ø: 3.75/4.25/4.75
Platform: 3.5
Code: 0040_B

NOVA IMPLANTS

Model: PSI/PCI
Implant Ø: 3.3/3.75/4.2/5/6
Platform: 3.75
Code: 0040_B

OSSTEM IMPLANT

Model: TS
Implant Ø: 3.5
Platform: Mini 3.5
Code: 0029

Model: TS
Implant Ø: 4/4.5/5/6/7
Platform: Regular
Code: 0030

Model: US
Implant Ø: 3.3/3.5
Platform: Mini 3.5
Code: 0023

Model: US
Implant Ø: 3.75/4/4.5
Platform: Regular 4.1
Code: 0024

COMPATIBILITIES AVAILABLE

Model: US
Implant Ø: 5/5.5
Platform: Wide 5.1
Code: 0061

Model: US
Implant Ø: 5/5.5
Platform: Wide PS 5
Code: 0088

Model: Multi Unit Abutment/
Esthetic Low abutment
Implant Ø: Universal
Platform: Regular
Code: 0025

OSTEOPLUS

Model: She
Implant Ø: 3.45
Platform: 3.45
Code: 0009

Model: She
Implant Ø: 3.75 / 4
Platform: 4
Code: 0024

Model: Shi
Implant Ø: 3.3 / 3.75 / 4.2
Platform: 3.5
Code: 0040

OXY

Model: K1 Line
Implant Ø: 3.5/4/4.5/5
Platform: Regular
Code: 0015

Model: K1 Line
Implant Ø: 3.5/6/6.5
Platform: Wide
Code: 0015

Model: PSK Line
Implant Ø: 3.5/4/4.5/5
Platform: Regular
Code: 0015

Model: MD Line KONE
Implant Ø: 3.75/4.25/5
Platform: Regular
Code: 0015

Model: MD Line Ext
Implant Ø: 3.75/4.25
Platform: Standard
Code: 0024

Model: Fixo
Implant Ø: Universal
Platform: 4.8
Code: 0242

PALTOP

Model: Advanced classic
Implant Ø: 3.25
Platform: Narrow (blue)
Code: 0229

Model: Advanced classic
Implant Ø: 3.75/4.2/5
Platform: Standard
Code: 0040_B

Model: Advanced classic
Implant Ø: 3.75/4.2/5
Platform: Standard
Code: 0042

Model: Advanced classic
Implant Ø: 6
Platform: Wide (purple)
Code: 0041

Model: Advanced +
Implant Ø: 3.25
Platform: Narrow (blue)
Code: 0229

Model: Advanced +
Implant Ø: 3.75/4.2/5
Platform: Standard
Code: 0040_B

Model: Advanced +
Implant Ø: 3.75/4.2/5
Platform: Standard
Code: 0042

Model: Advanced +
Implant Ø: 6
Platform: Wide (purple)
Code: 0041

Model: Dynamic
Implant Ø: 3.25
Platform: Narrow (blue)
Code: 0229

Model: Dynamic
Implant Ø: 3.75/4.2/5
Platform: Standard
Code: 0040_B

Model: Dynamic
Implant Ø: 3.75/4.2/5
Platform: Standard
Code: 0042

Model: Dynamic
Implant Ø: 6
Platform: Wide (purple)
Code: 0041

Model: PAI
Implant Ø: 3.25
Platform: Narrow (blue)
Code: 0229

Model: PAI
Implant Ø: 3.75/4.2/5
Platform: Standard
Code: 0040_B

Model: PAI
Implant Ø: 3.75/4.2/5
Platform: Standard
Code: 0042

Model: PAI
Implant Ø: 6
Platform: Wide (Purple)
Code: 0041

Model: DIVA/ACTIVE
Implant Ø: 3.75/4.2/5
Platform: Standard
Code: 0040_B

Model: DIVA/ACTIVE
Implant Ø: 3.75/4.2/5
Platform: Standard
Code: 0042

Model: Conical Active
Implant Ø: 3.25/3.75/4.2/5
Platform: Standard
Code: 0029

Model: Universal Multi-Unit
Implant Ø: Multi-Unit
Platform: Universal
Code: 0181

PHIBO

Model: TSH/BNT Serie 3
Implant Ø: 3.6
Platform: 4
Code: 0024

Model: TSH/BNT Serie 4
Implant Ø: 4.2
Platform: 4
Code: 0024

Model: TSH/BNT Serie 5
Implant Ø: 4.8
Platform: 5
Code: 0060

POINT IMPLANT

Model: SM II System UV Implant
Implant Ø: 4/4.5/5
Platform: Regular
Code: 0030

PROCLINIC

Model: Cilíndrico Externo
Implant Ø: 3.3
Platform: 3.3 Mini
Code: 0009

Model: Cilíndrico Externo/
Cónico Externo
Implant Ø: 3.75/4.25//3.5/4
Platform: 4.1 Estandar
Code: 0024

Model: Cilíndrico Externo/
Cónico Externo
Implant Ø: 5
Platform: 5 Maxi
Code: 0058

Model: Cilíndrico Interno/
Cónico Interno
Implant Ø:
3.3/3.75/4.25/5/3.5/4/5
Platform: 3.5
Code: 0040

Model: SP Octa
Implant Ø: 3.3/4.1/4.8
Platform: 4.8
Code: 0074

Model: SP Octa
Implant Ø: 3.3/4.1/4.8
Platform: 4.8
Code: 0037

Model: SP Octa
Implant Ø: 4.8
Platform: 6.5
Code: 0096

Model: Aqua CM
Implant Ø: 3.5/4/5
Platform: 2.82
Code: 0004

PROTEG IMPLANTS

Model: PR01
Implant Ø: 3.3/3.75/4.2/5/6
Platform: Narrow
Code: 0265

RADHEX

Model: PHE
Implant Ø: 3.5
Platform: 3.5
Code: 0023

Model: PHE
Implant Ø: 4/4.5/5
Platform: 4.1
Code: 0024

Model: PHI
Implant Ø: 3.5
Platform: 3.5
Code: 0040_B

Model: PHI
Implant Ø: 4.5/5
Platform: 4.5
Code: 0041_B

REFLECT

Model: Rapid
Implant Ø: 3.0
Platform: 3.0
Code: 0159

Model: Rapid
Implant Ø: 3.5
Platform: NP
Code: 0021

RITTER

Model: SB/LA/QSI
Implant Ø: 3.75/4.2/5/6
Platform: Standard
Code: 0040_B

COMPATIBILITIES AVAILABLE

Model: Rapid
Implant Ø: 4.3/5/5.5
Platform: RP
Code: 0022

Model: Recover
Implant Ø: 3.5
Platform: NP
Code: 0021

Model: Recover
Implant Ø: 4.3/5
Platform: RP
Code: 0022

Model: Aspire
Implant Ø: 3.5/4
Platform: Aqual(Estrecha)
Code: 0004

Model: Aspire
Implant Ø: 5
Platform: Lilac (Ancha)
Code: 0005

Model: Tapered Screw
Implant Ø: 3.5
Platform: 3.5
Code: 0040_B

Model: Tapered Screw
Implant Ø: 4.1/4.7
Platform: 4.5
Code: 0041

ROOT

Model: R
Implant Ø: 3.5/3.8/4.2/4.8/5.5
Platform: Universal
Code: 0236

SEWON MEDIX

Model: IH2 SLA SYSTEM
Implant Ø: 3.5
Platform: Mini
Code: 0029

Model: IH2 SLA SYSTEM
Implant Ø: 3.5/4/4.5/5
Platform: Regular
Code: 0030

Model: IH2 RBM SYSTEM
Implant Ø: 3.5
Platform: Mini
Code: 0029

Model: IH2 RBM SYSTEM
Implant Ø: 3.5/4/4.5/5
Platform: Regular
Code: 0030

Model: IH SYSTEM
Implant Ø: 3.5/4/4.5/5
Platform: Universal
Code: 0025

SIC INVENT

Model: HEXAGONAL SYSTEM
SICace
Implant Ø: 3.4/4
Platform: 3.3
Code: 0170

Model: HEXAGONAL SYSTEM
SICace
Implant Ø: 4.5/5
Platform: 4.2
Code: 0171

Model: HEXAGONAL SYSTEM
SICMax
Implant Ø: 3.4/4.2
Platform: 3.3
Code: 0170

Model: HEXAGONAL SYSTEM
SICMax
Implant Ø: 4.7/5.2
Platform: 4.2
Code: 0171

Model: HEXAGONAL SYSTEM
SICtapered
Implant Ø: 3.4/4.2
Platform: 3.3
Code: 0170

Model: HEXAGONAL SYSTEM
SICtapered
Implant Ø: 4.7/5.2
Platform: 4.2
Code: 0171

SIGNO VINCES

Model: Duo
Implant Ø: 4.6
Platform: 4.1
Code: 0024

Model: Integra
Implant Ø: 3.75/4
Platform: 4.1
Code: 0024

Model: Compact
Implant Ø: 4.5
Platform: CM3.8
Code: 0004

Model: Duocon
Implant Ø: 3.8
Platform: CM3.8
Code: 0004

Model: Duocon
Implant Ø: 4.6/5.5
Platform: CM4.6
Code: 0005

Model: Infra
Implant Ø: 3.3/3.8/4.6
Platform: CM
Code: 0004

SIN IMPLANTS

Model: HE
Implant Ø: 3.75
Platform: 4.1
Code: 0024

Model: HI SW
Implant Ø: 3.8
Platform: 3.8
Code: 0039

Model: Tryon
Implant Ø: 3.25/3.75/4
Platform: 4.1
Code: 0024

Model: Tryon CO
Implant Ø: 4
Platform: 4.1
Code: 0024

Model: Revolution
Implant Ø: 3.25/3.75/4
Platform: 4.1
Code: 0024

Model: Stylus
Implant Ø: 4
Platform: 4.1
Code: 0024

Model: Epikut/Epikut Plus
Implant Ø: 4.5
Platform: 4.5
Code: 0024

Model: Epikut/Epikut Plus
Implant Ø: 5
Platform: 5
Code: 0058

Model: Mini Pilar
Implant Ø: Universal
Platform: Universal
Code: 0025

SOUTHAREN IMPLANTS

Model: Tri-Nex
Implant Ø: 3.5
Platform: 3.5
Code: 0026

Model: Tri-Nex
Implant Ø: 4.3
Platform: 4.3
Code: 0027

Model: Tri-Nex
Implant Ø: 5
Platform: 5
Code: 0028

Model: Tri-Nex
Implant Ø: 6
Platform: 6
Code: 0129

Model: IT Connection
Implant Ø: 3.3/4/4.1/4.9/5
Platform: 4.8
Code: 0037

Model: IT Connection
Implant Ø: 4.9/5/6
Platform: 6.5
Code: 0096

Model: External Hex
Implant Ø: 3.25
Platform: 3.4
Code: 0003

Model: External Hex
Implant Ø: 3.75/4
Platform: 4.1
Code: 0024

Model: External Hex
Implant Ø: 4.7/5
Platform: 5
Code: 0058

Model: External Hex
Implant Ø: 5.7/6
Platform: 6
Code: 0058

Model: Deep Conical
Implant Ø: 3
Platform: 2.45
Code: 0109

Model: Deep Conical
Implant Ø: 3.5/4
Platform: 2.95/3.1
Code: 0004

Model: Deep Conical
Implant Ø: 5
Platform: 4.1
Code: 0005

Model: Internal Hex
Implant Ø: 3.75/4.2/5
Platform: Universal
Code: 0040

Model: Provata
Implant Ø: 4/5/6
Platform: Standard
Code: 0040

Model: Compact Conical
Implant Ø: 4.8
Platform: 4.8
Code: 0025

STERI-OSS

Model: Hex-Loc
Implant Ø: 3.25
Platform: 3.3
Code: 0023

STERNGOLD

Model: STERN EX
Implant Ø: 3.75/4/5
Platform: 4.1
Code: 0024

STRAUMANN

Model: Tissue Level
Implant Ø: 3.3
Platform: 3.5
Code: 0160

Model: Tissue Level
Implant Ø: 3.3/4.1/4.8
Platform: Regular 4.8
Code: 0037

Model: Tissue Level
Implant Ø: 4.8
Platform: Wide 6.5
Code: 0096

COMPATIBILITIES AVAILABLE

Model: Synocta
Implant Ø: 4
Platform: Regular 4.8
Code: 0074

Model: Synocta
Implant Ø: 4
Platform: Wide 6.5
Code: 0137

Model: Bone Level Tapered SC
Implant Ø: 2.9
Platform: SC- 2.9
Code: 0135

Model: Bone Level
Implant Ø: 3.3
Platform: NC- 3.3
Code: 0033

Model: Bone Level
Implant Ø: 4.1
Platform: RC-4.1
Code: 0035

Model: Bone Level
Implant Ø: 4.8
Platform: RC-4.8
Code: 0035

Model: Screw-Retained
Implant Ø: NC/RC Ø4,6
Platform: Universal
Code: 0101

Model: BLX
Implant Ø: 3.5/3.75/4/4.5
Platform: RB (Regular Base)
Code: 0207

Model: BLX
Implant Ø: 5/5.5/6.5
Platform: WB (Wide Base)
Code: 0208

Model: BLC
Implant Ø: 3.3/3.75
Platform: RB
Code: 0207

Model: BLC
Implant Ø: 4.5/5.5/6.5
Platform: WB
Code: 0208

Model: TLX / TLX S
Implant Ø: 3.75/4.5
Platform: NT
Code: 0260

Model: TLX / TLX S
Implant Ø: 3.75/4.5
Platform: RT
Code: 0261

Model: TLX / TLX S
Implant Ø: 5.5/6.5
Platform: WT
Code: 0262

Model: TLC
Implant Ø: 3.3
Platform: NT
Code: 0260

Model: TLC
Implant Ø: 3.3/3.75/4.5
Platform: RT
Code: 0261

Model: TLC
Implant Ø: 4.5/5.5/6.5
Platform: WT
Code: 0262

SURCAM DENTAL

Model: Multi Unit
Implant Ø:
Platform: Universal
Code: 0181

SYBRON IMPLANT SOLUTIONS

Model: Endopore (Innova)
Implant Ø: 4.1
Platform: 4.1
Code: 0024

SYSTHEX

Model: Classic-ci / Estetic-ci
Implant Ø: 3.5/3.75/4
Platform: 4.1
Code: 0024

TBR

Model: Hex-Conic
Implant Ø: 3.5
Platform: Narrow
Code: 0023

Model: Hex-Conic
Implant Ø: 5
Platform: Wide
Code: 0058

Model: Connect / Infinity
Implant Ø: 3.5
Platform: 3.5
Code: 0266

Model: Connect / Infinity
Implant Ø: 4
Platform: 4
Code: 0267

Model: Connect / Infinity
Implant Ø: 5
Platform: 5
Code: 0268

Model: Baby 8
Implant Ø: 4
Platform: 4
Code: 0267

Model: Baby 8
Implant Ø: 5
Platform: 5
Code: 0268

TITANIUM-FIX

Model: b-fix
Implant Ø: 3.5/4
Platform: Regular
Code: 0004

Model: b-fix
Implant Ø: 4.5/5
Platform: Larga
Code: 0005

TREE-OSS

Model: Simple
Implant Ø: 3.3/3.75/5
Platform: 3.75 Amarillo
Code: 0040

Model: Rapid/Anatomic
Implant Ø: 3.3
Platform: 3.5 Rosa
Code: 0023

Model: Rapid/Anatomic
Implant Ø: 3.75/4
Platform: 4.1 Amarillo
Code: 0024

Model: Rapid/Anatomic
Implant Ø: 5
Platform: 5.1 Azul
Code: 0061

Model: Anatomic/HS
Implant Ø: 3.5
Platform: 3.5 Rosa
Code: 0026

Model: Anatomic/HS
Implant Ø: 4.3
Platform: 4.3 Amarillo
Code: 0027

Model: Anatomic/HS
Implant Ø: 5
Platform: 5 Azul
Code: 0028

Model: Multi Unit
Implant Ø:
Platform: Universal
Code: 0025

TRI DENTAL IMPLANTS

Model: TRI-Vent
Implant Ø: 3.75/4.1/4.7
Platform: 3.5
Code: 0040

Model: TRI-Vent
Implant Ø: 3.75/4.1/4.7
Platform: 3.5
Code: 0042

TRINON

Model: O2
Implant Ø: 3.5/3.75/4.5
Platform: 4
Code: 0024

Model: OK
Implant Ø: 4
Platform: 4.8
Code: 0074

Model: OK
Implant Ø: 4
Platform: 4.8
Code: 0037

UFIT

Model: Gtz
Implant Ø: 3.5
Platform: Mini
Code: 0004

Model: Gtz
Implant Ø: 4/4.5
Platform: Regular
Code: 0005

Model: Gtz
Implant Ø: 5
Platform: Wide
Code: 0005

Model: Gtz
Implant Ø: 5.5/6/6.5/7
Platform: Ultra-wide
Code: 0005

Model: Ntz
Implant Ø: 3.5
Platform: Mini
Code: 0004

Model: Ntz
Implant Ø: 4/4.5
Platform: Regular
Code: 0005

Model: Ntz
Implant Ø: 5
Platform: Wide
Code: 0005

Model: Ntz
Implant Ø: 5.5/6/6.5/7
Platform: Ultra-wide
Code: 0005

COMPATIBILITIES AVAILABLE

VULKAN IMPLANTS

Model: IN-Hex
Implant Ø: 3.3/3.75/4.2/5
Platform: 3.75
Code: 0040

WARANTEC (ONEPLANT)

Model: IU Implant System
Implant Ø: 3.3/3.6
Platform: Mini
Code: 0004

Model: UT Implant System
Implant Ø: 3.6
Platform: Mini
Code: 0004

WIN

Model: WIN
Implant Ø: 3.30/3.75/4.25/5
Platform: 3.75
Code: 0040_B

Model: WIN
Implant Ø: Universal
Platform: Universal
Code: 0025

XIVE

Model: Xive
Implant Ø: 3
Platform: 3
Code: 0084

Model: Xive
Implant Ø: 3.4
Platform: 3.4
Code: 0038

Model: Xive
Implant Ø: 3.8
Platform: 3.8
Code: 0039

Model: Xive
Implant Ø: 4.5
Platform: 4.5
Code: 0085

Model: Xive
Implant Ø: 5.5
Platform: 5.5
Code: 0086

YES IMPLANT

Model: S-SYSTEM
Implant Ø: 3.3/3.5
Platform: Narrow
Code: 0030

Model: S-SYSTEM
Implant Ø: 4/4.5
Platform: Regular
Code: 0030

Model: S-SYSTEM
Implant Ø: 5/5.5
Platform: Wide
Code: 0030

ZIACOM

Model: OEX
Implant Ø: 3.75/4.25
Platform: RP 4.1
Code: 0024

Model: ZINIC
Implant Ø: 3.7/4/4.3
Platform: RP 3.5
Code: 0040_B

Model: ZINIC Shorty
Implant Ø: 4.75
Platform: RP 3.5
Code: 0040_B

Model: GALAXY
Implant Ø: 3.4/3.7/4
Platform: RP 2.85
Code: 0004

ZIMMER

Model: Screw-Vent
Implant Ø: 3.7/4.1
Platform: 3.5
Code: 0040

Model: Screw-Vent
Implant Ø: 3.7/4.1
Platform: 3.5
Code: 0042

Model: Screw-Vent
Implant Ø: 4.7
Platform: 4.5
Code: 0041

Model: Screw-Vent
Implant Ø: 4.7
Platform: 4.5
Code: 0043

Model: Screw-Vent
Implant Ø: 6
Platform: 5.7
Code: 0080

Model: TSX Implant
Implant Ø: 3.1
Platform: 2.9
Code: 0178

Model: TSX Implant
Implant Ø: 3.7/4.1/4.7
Platform: 3.5
Code: 0040

Model: TSX Implant
Implant Ø: 3.7/4.1/4.7
Platform: 3.5
Code: 0042

Model: TSX Implant
Implant Ø: 5.4/6
Platform: 4.5
Code: 0041

Model: TSX Implant
Implant Ø: 5.4/6
Platform: 4.5
Code: 0043

Model: Swiss-Plus
Implant Ø: 3.7/4.1/4.8
Platform: 4.8
Code: 0074

Model: Swiss-Plus
Implant Ø: 3.7/4.1/4.8
Platform: 4.8
Code: 0037

Model: Eztecic
Implant Ø: 3.1
Platform: 2.9
Code: 0178

Model: Tapered Abutment
Implant Ø: Universal
Platform: Universal
Code: 0205

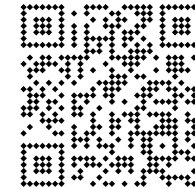

This printed version is probably outdated and may not include all products or compatibilities.

Scan and download the latest version of this catalogue

www.dynamicabutment.com

TALLADIUM GUARANTEE

TERMS AND CONDITIONS

These guarantee terms and conditions ("T&C") cover the entire range of Talladium products ("Products"), manufactured by TALLADIUM ESPAÑA S.L. and distributed by Geoda Medical S.L. or official dealers. The guarantee described in these T&C is exclusively in benefit of the clinician ("Clinician") and of the dental technician ("Technician") and not for the benefit of third parties or institutions, including patients.

GUARANTEE PERIOD

TALLADIUM ESPAÑA S.L. offers a lifelong guarantee for its entire range of products starting from the date of issue of the invoice.

GUARANTEE SCOPE

Subject to the limitations and exceptions described in these T&C, TALLADIUM ESPAÑA S.L. will offer the following benefits:

QUALITY: If there are defects in the materials or in the manufacturing of the Product, TALLADIUM ESPAÑA S.L. will replace the Product with no additional cost.

SAFETY: If, having complied with all the product indications, the prosthesis should have to be made again, due to a fault in the Dynamic Abutment or Dynamic Titanium Base system, TALLADIUM ESPAÑA S.L. will replace the abutments and screws necessary to remake the prosthesis, as well as the costs derived from its manufacturing.

In case of having used our products and having complied with all the product indications, the implants suffer any damage, TALLADIUM ESPAÑA S.L. will pay the cost of the implants. This coverage will only be valid during the first 6 months after the collocation of the prosthesis which includes our products.

CLAIM REQUIREMENTS AND PROCEDURE

To receive the benefits indicated in these T&C, the treating Clinician must satisfy the following requirements:

- a) The claim must be notified to TALLADIUM ESPAÑA S.L. within (30) days since the date the claimed defect was detected.
- b) This requires that the Clinician or Technician must contact the customer service department by telephone or by e-mail to make the claim.
- c) A claim form will be completed, which, together with a document or report which justifies the faulty Product and the faulty Product itself, will be sent by the customer to TALLADIUM ESPAÑA S.L. offices, within the previously indicated period.
- d) Clinicians or Technicians presenting a claim in agreement with these T&C must be up to date in any payments owing to TALLADIUM ESPAÑA S.L. or to any of its subsidiaries, at the time when the claim form is presented.
- e) All the use procedures of our Products must be carried out in agreement with the instructions of TALLADIUM ESPAÑA S.L. as well as in accordance with commonly accepted dentistry practices.
- f) The expenses derived from this procedure will be assumed by the customer. The return shipping costs will be assumed by TALLADIUM ESPAÑA S.L. in all those cases covered by these T&C. Regardless of the guarantee rights, claims should be notified as soon as possible in order to comply with regulatory requirements.

GENERAL LIMITATIONS OF THIS GUARANTEE

With the exception of the guarantee described in these T&C, neither TALLADIUM ESPAÑA S.L. nor its representatives, nor third parties manufacturing or distributing the Products, represent or offer a guarantee, agreement or any other express or implicit, oral or written, commitment, with respect to the Products (without limitation), including guarantees involved in the marketing, durability or suitability for individual uses or purposes. In addition and within the maximum extent permitted by the relative law, TALLADIUM ESPAÑA S.L. rejects (on its own behalf, and on behalf of its representatives and third parties that manufacture or distribute Products) any responsibility with respect to any direct or indirect damage caused, which may result from or be a consequence of the design, composition of the dental prosthesis into which the Products are integrated.

GUARANTEE EXCLUSIONS

TALLADIUM ESPAÑA S.L. limits this guarantee to:

- Transformed abutments that form part of the dental prosthesis. But not the screws used to anchor them.
- Those products that are not used with the accessories and parts marketed by Talladium España

AMENDMENT OR SUSPENSION OF THE GUARANTEE

TALLADIUM ESPAÑA S.L. reserves the right to amend or withdraw these T&C at any time and without prior notification. Any modification or suspension shall not affect products already placed in patients.



Virginia Woolf, 17
25005 · Lleida (Spain)

INTERNATIONAL +34 873 450 709
das@dynamicabutment.com

SPAIN +34 973 289 580
spain@dynamicabutment.com



www.dynamicabutment.com

