

DYNAMIC
ABUTMENT
SOLUTIONS

PROSTHETIC
SOLUTIONS

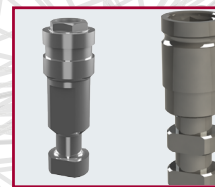

Angulated
Own Technology
DYNAMIC ABUTMENT SOLUTIONS

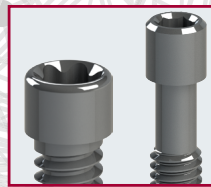
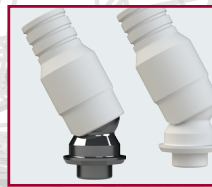

DYNAMIC ABUTMENT SOLUTIONS

VIRGINIA WOOLF, 17 · 25005 · LLEIDA (SPAIN)
TEL. +34 973 289 580
das@dynamicabutment.com
www.dynamicabutment.com

All commercial trademarks mentioned herein are fully registered by their respective companies, and the images that appear are just to provide an orientation.

Talladium reserves the right to modify this document without previous notice.

Talladium is not responsible for the inadequate execution of these products if the warning indications corresponding to every reference are not contemplated.

The information included in this catalogue is exclusively addressed to professionals in dental sector.

 Approval of total quality system assurance by notified body, according to Community legislation, for sterile and medical devices Class IIB.
Class IIB includes: screws and abutments.



Visit our Online Store to find all our products and compatibilities :

www.dynamicabutmentstore.com

INDEX

5	<i>LIST OF 3.0 DYNAMIC ABUTMENT® COMPATIBILITIES</i>
6	<i>RESEARCH & DEVELOPMENT</i>
7	<i>QUALITY CENTER & INTERNATIONAL CUSTOMER SERVICE</i>
8	<i>DYNAMIC SYSTEM FOR MILLING STRUCTURES</i>
10	<i>3.0 DYNAMIC ABUTMENT®</i>
13	<i>SECURITY & TRACEABILITY</i>
14	<i>3.0 DYNAMIC ABUTMENT® COMPATIBILITIES</i>
60	<i>DYNAMIC SCREWS TECHNICAL SPECIFICATIONS</i>
62	<i>STRAIGHT ABUTMENTS COMPATIBILITIES</i>
79	<i>STRAIGHT SCREWS & SCREWDRIVERS</i>
80	<i>STRAIGHT SCREWS TECHNICAL SPECIFICATIONS</i>
82	<i>COMPLEMENTS & ANALOGS</i>
83	<i>PROSTHETIC REAMER</i>
84	<i>TALLADIUM GUARANTEE</i>

3.0 Dynamic Abutment



List of 3.0 DYNAMIC ABUTMENT® compatibilities

AB	14	CORTEX	29	MPI	45
ACE	15	DENTAL TECH	30	NEOBIOTECH	46
ADIN	16	DENTIS	30	NEODENT	46
ALPHABIO	17	DENTIUM	31	NOBEL BIOCARE	47
ANCLADEN	18	DIO IMPLANTS	32	NORMON	48
ANKYLOS	18	DSP BIOMEDICAL	33	OSSEOLIFE (ZIACOM)	48
ANTHOGRYR	19	ECKERMAN	33	OSSTEM IMPLANT	49
ARDS	19	ELITE MEDICAL	33	OSTEOPLUS	50
ASTRA	20	EUROTEKNIKA	34	PALTOP	51
AVINENT	21	GALIMPLANT	36	PHIBO	51
BEGO	22	GMI (ILERIMPLANT)	36	PROCLINIC	52
BIOGENESIS	22	GT MEDICAL	37	RADHEX	52
BIOCONCEPT	22	HI-TECH	37	SEWON MEDIX	53
BIOHORIZON	23	HIOSSEN	38	SGS	53
BIOMET 3I	24	IHDE DENTAL (IMBIODENT)	38	SIGNO VINCES	54
BIOLOK	25	IMPLANT DIRECT	39	SOUTHERN IMPLANTS	55
BIONER	25	JDENTALCARE	40	STRAUMANN	56
BIOTEC	26	KEYSTONE	40	SYBRON IMPLANTS SOLUTIONS	57
BIOTECH	26	KLOCKNER	41	TBR	57
BTI	27	LEADER	41	TITANIUM-FIX	58
BTK	28	MEGAGEN	42	TRI DENTAL IMPLANTS	58
B&W	28	MICRODENT	43	TRINON	58
CONEXÃO SISTEMA DE PRÓTESE	29	MIS	44	ZIMMER	59
		MOZO GRAU	45		

Research & Development

Always ready to be trendsetters

Our main purpose is to keep leading the way in angled systems, that is why our research and innovation in prosthetic solutions are our hallmarks.

The proximity to professional needs and the innovative philosophy of our brand allow our technical team to be at the cutting edge of the sector. When developing the product, we give priority to product output, ease of use and improvement in terms of the aesthetic result.

Research and development of new products have been our main objectives. This enabled us to create innovative projects responding to sector needs.

The result (in the shape of numerous patents presented by our R&D&I Department) has been new products launched onto the market, fruit of work done in our R&D&I department and a good working relationship with the best people and leading companies in the sector that, like Dynamic Abutment® Solutions, champion research and development.

Dynamic Abutment Solutions: always ready to be trendsetters. That is why we have started our **Production Center**: our own production center which allows us to rapidly create prototypes for new products and undertake applied research into new technologies.

The UNE-166002 certified R&D&I Centre ensures an exhaustive control of all the developmental stages for new projects. This enables these projects to turn into new products to the benefit of our clients as rapidly as possible and under the highest levels of safety and quality.



Quality Center

Dynamic Abutment Solutions features significant resources to ensure our clients receive products in the very best quality and safety guaranteed.

It has the latest marking, control and measurement equipment, in addition to specific features to effect physical-chemical treatments on our products .

Our presence in international markets means we have the mandatory healthcare certificates supporting our medical devices: CE marking, CMD/CAS standards and FDA certificates.

One of our primary commitments is the guarantee that the devices which we make available to our clients fully meet all healthcare regulations.

Our primary concern from the very beginning has been the quality and safety of our products: UNE-EN ISO 9001:2015 , UNE-EN ISO 13485:2016, and UNE 166002:2014



The Quality Center has an ISO-8 clean room



Quality Management System



Medical devices



Health Canada Certified



FDA Clearance

International Customer Service

At Dynamic Abutment Solutions we are very proud to offer an excellent customer service. Our aim is to establish constant communication with our international distributors and partners. We offer instant replies and solutions, answers to your queries, and provide technical advice for more complex cases.

Our international department also offers support to register our products in other countries.

Direct contact with and suggestions from our clients allow us to continuously improving the quality of the products and services we offer on a daily basis.



Participation in events, exhibitions and trainings

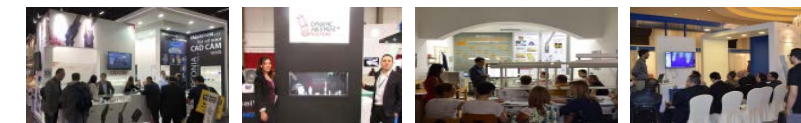

Dynamic System

more than
100.000 cases
resolved by
Dynamic System

The Screwdriver set of 3.0 Dynamic Abutment System is used in those cases in which rectification of the entry of the screw due to an unfavorable position of the implants is necessary, improving the functionality and aesthetics of the milled prosthesis.

Dynamic Screwdriver

Screwdriver with hexalobular head, exclusively to the 3.0 Dynamic Abutment system; lengths: 18, 24, 32mm. Our screwdriver has a contra-angle connection to make it easier to use with a dynamometer or manual ratchet, with the corresponding adaptors or handles.

Dynamic Screws

They cover all the tread metrics available on the market. They are used with the 3.0 Dynamic Abutment, the 3.0 Dynamic TiBase® or milled structures with an angled screw channel of up to 30°. There are several lengths for each metric to ease adaptation to the structures. All of them are made of grade 5 titanium

All screws are perfectly identified with their batch and reference numbers, which allow each and every screw to be traced and recorded in the patient's card and in the clinical or laboratory records. Only the 3.0 dynamic screwdriver must be used to fix them.



3.0 Dynamic Abutment

Our unique and exclusive 3.0 Dynamic Abutment System has stirred the implantology sector, as it achieves a screw-retained prosthesis even if the implants have been placed inaccurately and its functionality is no longer affected nor its aesthetics compromised. It is an outstanding alternative to titanium fix angled cement-to abutments and individual dies made by the technician.

Our abutments provide a perfect adjustment to avoid any modification on the prosthetic connection geometry with the implant during the prosthesis production.



Machined abutments



Cast-to Dynamic Abutment 3.0 with Cobalt-Chrome milled base.

Abutment with milled Cobalt-Chrome base and castable chimney. It must be cast in Cobalt-Chrome alloy.



Castable 3.0 Dynamic Abutment

Fully castable abutment. It is produced with sanitary plastic POM of the highest quality. It can be cast in any alloy used in the laboratory.

Total freedom of movement

The Dynamic Abutment consists of two pieces connected by an elbow. The elbow connection works as a joint to offer the chimney a full 360° rotation and angle correction up to 28°.

Our Dynamic Abutment is a revolutionary solution as it gives technicians total freedom of movement and, at the same time, allows angle correction. It simplifies the prosthetic work and, what is more important, provides solutions.



Example of use

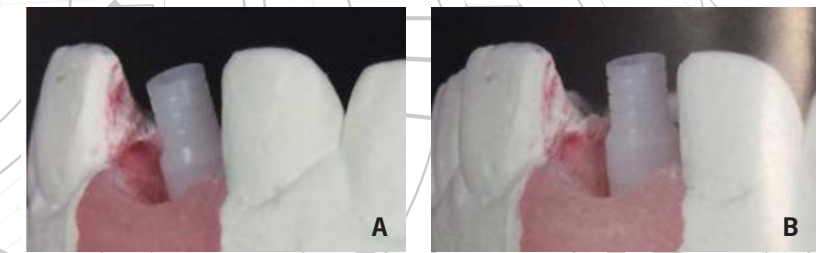

Dynamic Abutment in a model.
Image A: with no angle correction.
Image B: with angle correction. The screw entry is now in a palatal position.
Article published in "The Journal of prosthetic dentistry" (June 2015).
By: Eva Berroeta



Security & Traceability

All of our products are **patented** and manufactured under very strict quality guidelines.

With the 3.0 Dynamic System, we provide a **card for the patient** and **labels** for the laboratory and the clinic to identify the position in Dynamic System is located.

We exercise complete control over the traceability of our products to fulfil the current health legislation.

This helps repositioning the material and inform about the importance of using the appropriate tools when handling the Dynamic System components.

Exclusivity

All of our products are marked during the manufacturing process to ensure the exclusivity of each piece and control traceability.

This logo is exclusive to Dynamic Abutment Solutions and guarantees the products are original and have successfully achieved the highest quality standards in our Quality Center.

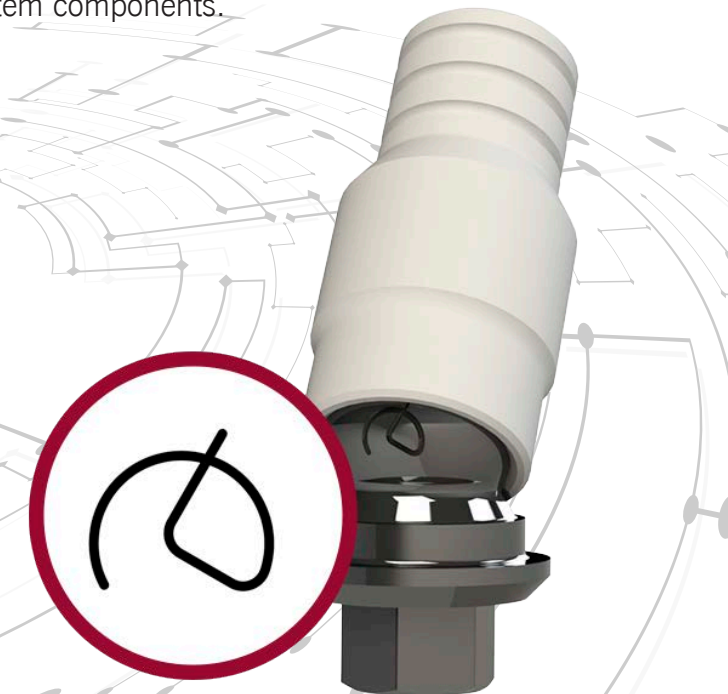

Compatible with - AB

MODEL	IMPLANT DIAMETER	PLATFORM	(R) NON-ENGAGING (NR) ENGAGING	DYNAMIC ABUTMENT®			
				POM	COBALT-CHROME	DYNAMIC SCREW	ANALOG
I2	3,5/3,75/4,2/4,5/	Standard	R	21.522.040.01-2	21.222.040.01-2	41.317.071.01-2	22.612.040.01-2
	3,5/3,75/4,2/4,5/	Standard	NR	21.512.040.01-2	21.212.040.01-2	41.317.071.01-2	22.612.040.01-2
	5/6	Standard	R	21.522.040.01-2	21.222.040.01-2	41.317.071.01-2	22.612.040.01-2
	5/6	Standard	NR	21.512.040.01-2	21.212.040.01-2	41.317.071.01-2	22.612.040.01-2
I22	3,75/4,22	Standard	R	21.522.040.01-2	21.222.040.01-2	41.317.071.01-2	22.612.040.01-2
	3,75/4,22	Standard	NR	21.512.040.01-2	21.212.040.01-2	41.317.071.01-2	22.612.040.01-2
I5	3,5/3,75/4,2/4,5/	Standard	R	21.522.040.01-2	21.222.040.01-2	41.317.071.01-2	22.612.040.01-2
	3,5/3,75/4,2/4,5/	Standard	NR	21.512.040.01-2	21.212.040.01-2	41.317.071.01-2	22.612.040.01-2
	5/6/7/8	Standard	R	21.522.040.01-2	21.222.040.01-2	41.317.071.01-2	22.612.040.01-2
	5/6/7/8	Standard	NR	21.512.040.01-2	21.212.040.01-2	41.317.071.01-2	22.612.040.01-2
I55	3,75/4,2/4,5	Standard	R	21.522.040.01-2	21.222.040.01-2	41.317.071.01-2	22.612.040.01-2
	3,75/4,2/4,5	Standard	NR	21.512.040.01-2	21.212.040.01-2	41.317.071.01-2	22.612.040.01-2
	5/6/7/8	Standard	R	21.522.040.01-2	21.222.040.01-2	41.317.071.01-2	22.612.040.01-2
	5/6/7/8	Standard	NR	21.512.040.01-2	21.212.040.01-2	41.317.071.01-2	22.612.040.01-2
I10	4,2/5	Standard	R	21.522.040.01-2	21.222.040.01-2	41.317.071.01-2	22.612.040.01-2
	4,2/5	Standard	NR	21.512.040.01-2	21.212.040.01-2	41.317.071.01-2	22.612.040.01-2
I15	6/7/8	Standard	R	21.522.040.01-2	21.222.040.01-2	41.317.071.01-2	22.612.040.01-2
	6/7/8	Standard	NR	21.512.040.01-2	21.212.040.01-2	41.317.071.01-2	22.612.040.01-2

Compatible with - ACE

MODEL	IMPLANT DIAMETER	PLATFORM	(R) NON-ENGAGING (NR) ENGAGING	DYNAMIC ABUTMENT®			
				POM	COBALT-CHROME	DYNAMIC SCREW	ANALOG
External Hex	3,3	NP 3,5	R	21.522.023.01-2	21.222.023.01-2	41.316.059.01-2	22.612.023.01-2
	3,3	NP 3,5	NR	21.512.023.01-2	21.212.023.01-2	41.316.059.01-2	22.612.023.01-2
	3,75/4	RP 4,1	R	21.523.024.01-2	21.223.024.01-2	41.320.060.01-2	22.613.024.01-2
	3,75/4	RP 4,1	NR	21.513.024.01-2	21.213.024.01-2	41.320.060.01-2	22.613.024.01-2
	4,75	WP 5	R	21.524.058.01-2		41.320.047.01-2	22.614.058.01-2
	4,75	WP 5	NR	21.514.058.01-2		41.320.047.01-2	22.614.058.01-2
TRI-CAM	3,5	3,5	R	21.522.026.01-2	21.222.026.01-2	41.318.075.01-2	22.612.026.01-2
	3,5	3,5	NR	21.512.026.01-2	21.212.026.01-2	41.318.075.01-2	22.612.026.01-2
	4,3*	4,3	R	21.523.027.01-2	21.223.027.01-2	41.320.082.01-2	22.613.027.01-2
	4,3*	4,3	NR	21.513.027.01-2	21.213.027.01-2	41.320.082.01-2	22.613.027.01-2
Internal Hex	3,7/4,1	3,5	R	21.522.040.01-2	21.222.040.01-2	41.317.071.01-2	22.612.040.01-2
	3,7/4,1	3,5	NR	21.512.040.01-2	21.212.040.01-2	41.317.071.01-2	22.612.040.01-2
	4,7/5,1	4,5	R	21.523.041.01-2	21.223.041.01-2	41.317.071.01-2	22.613.041.01-2
	4,7/5,1	4,5	NR	21.513.041.01-2	21.213.041.01-2	41.317.071.01-2	22.613.041.01-2

*Maximum angulation 20°

Compatible with - ADIN

MODEL	IMPLANT DIAMETER	PLATFORM	(R) NON-ENGAGING (NR) ENGAGING	DYNAMIC ABUTMENT®				
				POM	COBALT-CHROME	DYNAMIC SCREW	ANALOG	
Swell	3,3	3,45	R	21.522.040.01-2	21.222.040.01-2	41.317.071.01-2	22.612.040.01-2	
	3,3	3,45	NR	21.512.040.01-2	21.212.040.01-2	41.317.071.01-2	22.612.040.01-2	
	3,3	3,45	NR (ZIO)	21.512.042.01-2	21.212.042.01-2	41.317.071.01-2	22.612.040.01-2	
	3,75/4,2	3,6	R	21.522.040.01-2	21.222.040.01-2	41.317.071.01-2	22.612.040.01-2	
	3,75/4,2	3,6	NR	21.512.040.01-2	21.212.040.01-2	41.317.071.01-2	22.612.040.01-2	
	3,75/4,2	3,6	NR (ZIO)	21.512.042.01-2	21.212.042.01-2	41.317.071.01-2	22.612.040.01-2	
	5	4	R	21.522.040.01-2	21.222.040.01-2	41.317.071.01-2	22.612.040.01-2	
	5	4	NR	21.512.040.01-2	21.212.040.01-2	41.317.071.01-2	22.612.040.01-2	
	5	4	NR (ZIO)	21.512.042.01-2	21.212.042.01-2	41.317.071.01-2	22.612.040.01-2	
	6	4,6	R	21.522.040.01-2	21.222.040.01-2	41.317.071.01-2	22.612.040.01-2	
	6	4,6	NR	21.512.040.01-2	21.212.040.01-2	41.317.071.01-2	22.612.040.01-2	
	6	4,6	NR (ZIO)	21.512.042.01-2	21.212.042.01-2	41.317.071.01-2	22.612.040.01-2	
	Touareg-S / Touareg-OS	3,5	3,45	R	21.522.040.01-2	21.222.040.01-2	41.317.071.01-2	22.612.040.01-2
		3,5	3,45	NR	21.512.040.01-2	21.212.040.01-2	41.317.071.01-2	22.612.040.01-2
3,5		3,45	NR (ZIO)	21.512.042.01-2	21.212.042.01-2	41.317.071.01-2	22.612.040.01-2	
3,75/4,2		3,6	R	21.522.040.01-2	21.222.040.01-2	41.317.071.01-2	22.612.040.01-2	
3,75/4,2		3,6	NR	21.512.040.01-2	21.212.040.01-2	41.317.071.01-2	22.612.040.01-2	
3,75/4,2		3,6	NR (ZIO)	21.512.042.01-2	21.212.042.01-2	41.317.071.01-2	22.612.040.01-2	
5		4	R	21.522.040.01-2	21.222.040.01-2	41.317.071.01-2	22.612.040.01-2	
5		4	NR	21.512.040.01-2	21.212.040.01-2	41.317.071.01-2	22.612.040.01-2	
5		4	NR (ZIO)	21.512.042.01-2	21.212.042.01-2	41.317.071.01-2	22.612.040.01-2	
6		5	R	21.522.040.01-2	21.222.040.01-2	41.317.071.01-2	22.612.040.01-2	
6		5	NR	21.512.040.01-2	21.212.040.01-2	41.317.071.01-2	22.612.040.01-2	
6	5	NR (ZIO)	21.512.042.01-2	21.212.042.01-2	41.317.071.01-2	22.612.040.01-2		
Touareg CloseFit	3,5	RP	R	21.522.021.01-2	21.222.021.01-2	41.316.073.01-2	22.612.021.01-2	
	3,5	RP	NR	21.512.021.01-2	21.212.021.01-2	41.316.073.01-2	22.612.021.01-2	
	4,3/5	WP	R	21.523.022.01-2	21.223.022.01-2	41.320.075.01-2	22.613.022.01-2	
	4,3/5	WP	NR	21.513.022.01-2	21.213.022.01-2	41.320.075.01-2	22.613.022.01-2	

Compatible with - ALPHABIO

MODEL	IMPLANT DIAMETER	PLATFORM	(R) NON-ENGAGING (NR) ENGAGING	DYNAMIC ABUTMENT®			
				POM	COBALT-CHROME	DYNAMIC SCREW	ANALOG
SPI	3,3/3,75/4,2/5/6	Universal	R	21.522.040.01-2	21.222.040.01-2	41.317.071.01-2	22.612.040.01-2
	3,3/3,75/4,2/5/6	Universal	NR	21.512.040.01-2	21.212.040.01-2	41.317.071.01-2	22.612.040.01-2
ICE	3,7/3,75/4,2/4,65/5,3	Universal	R	21.522.040.01-2	21.222.040.01-2	41.317.071.01-2	22.612.040.01-2
	3,7/3,75/4,2/4,65/5,3	Universal	NR	21.512.040.01-2	21.212.040.01-2	41.317.071.01-2	22.612.040.01-2
DFI	3,3/3,75/4,2/4,5	Universal	R	21.522.040.01-2	21.222.040.01-2	41.317.071.01-2	22.612.040.01-2
	3,3/3,75/4,2/4,5	Universal	NR	21.512.040.01-2	21.212.040.01-2	41.317.071.01-2	22.612.040.01-2
ATID	3,3/3,75/4,2/5/6	Universal	R	21.522.040.01-2	21.222.040.01-2	41.317.071.01-2	22.612.040.01-2
	3,3/3,75/4,2/5/6	Universal	NR	21.512.040.01-2	21.212.040.01-2	41.317.071.01-2	22.612.040.01-2

Compatible with - ANCLADEN

MODEL	IMPLANT DIAMETER	PLATFORM	(R) NON-ENGAGING (NR) ENGAGING	DYNAMIC ABUTMENT®			
				POM	COBALT-CHROME	DYNAMIC SCREW	ANALOG
Anclalock	3,75/4,25/5	3,5	R	21.522.040.01-2	21.222.040.01-2	41.317.071.01-2	22.612.040.01-2
Anclalock	3,75/4,25/5	3,5	NR	21.512.040.01-2	21.212.040.01-2	41.317.071.01-2	22.612.040.01-2

Compatible with - ANKYLOS

MODEL	IMPLANT DIAMETER	PLATFORM	(R) NON-ENGAGING (NR) ENGAGING	DYNAMIC ABUTMENT®			
				POM	COBALT-CHROME	DYNAMIC SCREW	ANALOG
Ankylos		3,5	R*	21.522.009.01-2	21.222.009.01-2	41.316.044.01-2	
		4,5	R*	21.522.009.01-2	21.222.009.01-2	41.316.044.01-2	
		4,5	R*	21.522.009.01-2	21.222.009.01-2	41.316.044.01-2	
		4,5	NR*		21.212.009.01-2	41.316.044.01-2	
		4,5	NR*		21.212.009.01-2	41.316.044.01-2	
		5,5	R*	21.522.009.01-2	21.222.009.01-2	41.316.044.01-2	
		5,5	R*	21.522.009.01-2	21.222.009.01-2	41.316.044.01-2	
		5,5	NR*		21.212.009.01-2	41.316.044.01-2	
		5,5	NR*		21.212.009.01-2	41.316.044.01-2	
		7	R*	21.522.009.01-2	21.222.009.01-2	41.316.044.01-2	
		7	R*	21.522.009.01-2	21.222.009.01-2	41.316.044.01-2	
		7	NR*		21.212.009.01-2	41.316.044.01-2	
		7	NR*		21.212.009.01-2	41.316.044.01-2	

Compatible with - ANTHOGRYR

MODEL	IMPLANT DIAMETER	PLATFORM	(R) NON-ENGAGING (NR) ENGAGING	DYNAMIC ABUTMENT®			
				POM	COBALT-CHROME	DYNAMIC SCREW	ANALOG
	3,5/3,75/4	R (4,1)	R	21.523.024.01-2	21.223.024.01-2	41.320.065.01-2	22.613.024.01-2
	3,5/3,75/4	R (4,1)	NR	21.513.024.01-2	21.213.024.01-2	41.320.065.01-2	22.613.024.01-2
	5	L (5)	R	21.524.058.01-2		41.320.065.01-2	22.614.058.01-2
	5	Wide	NR	21.514.058.01-2		41.320.065.01-2	22.614.058.01-2
	3,5/4,2	4,8	R*	21.523.074.01-2		41.320.050.01-2	22.613.074.01-2
	3,5/4,2	4,8	NR*	21.513.074.01-2		41.320.050.01-2	22.613.074.01-2

Compatible with - ARDS

MODEL	IMPLANT DIAMETER	PLATFORM	(R) NON-ENGAGING (NR) ENGAGING	DYNAMIC ABUTMENT®			
				POM	COBALT-CHROME	DYNAMIC SCREW	ANALOG
Smart	3,75/4,2/4,5	3,75	R	21.522.040.01-2	21.222.040.01-2	41.317.071.01-2	22.612.040.01-2
	3,75/4,2/4,5	3,75	NR	21.512.040.01-2	21.212.040.01-2	41.317.071.01-2	22.612.040.01-2
Classic	3,75/4,2/4,5	3,75	R	21.522.040.01-2	21.222.040.01-2	41.317.071.01-2	22.612.040.01-2
	3,75/4,2/4,5	3,75	NR	21.512.040.01-2	21.212.040.01-2	41.317.071.01-2	22.612.040.01-2
	3,3/3,75/4,2/5/6	3,75	R	21.522.040.01-2	21.222.040.01-2	41.317.071.01-2	22.612.040.01-2
Premium	3,3/3,75/4,2/5/6	3,75	NR	21.512.040.01-2	21.212.040.01-2	41.317.071.01-2	22.612.040.01-2
	3,3/3,75/4,2/5/6	3,75	R	21.522.040.01-2	21.222.040.01-2	41.317.071.01-2	22.612.040.01-2

Compatible with - ASTRA

MODEL	IMPLANT DIAMETER	PLATFORM	(R) NON-ENGAGING (NR) ENGAGING	DYNAMIC ABUTMENT®			
				POM	COBALT-CHROME	DYNAMIC SCREW	ANALOG
Aqua	3,5/4	Aqua(Narrow)	R	21.523.004.01-2	21.223.004.01-2	41.316.076.01-2	22.613.004.01-2
	3,5/4	Aqua(Narrow)	NR	21.513.004.01-2	21.213.004.01-2	41.316.076.01-2	22.613.004.01-2
Cone 20°		Regular/Wide	R	21.523.066.01-2		41.314.040.01-2	
Cone 45°		Regular/Wide	R	21.523.067.01-2		41.314.040.01-2	
Evolution (Internal)	3,6	3.6	R	21.522.006.01-2	21.222.006.01-2	41.316.072.01-2	
	3,6	3.6	NR		21.212.006.01-2	41.316.072.01-2	
	4,2	4.2	R	21.523.007.01-2	21.223.007.01-2	41.318.074.01-2	
	4,2	4.2	NR		21.213.007.01-2	41.318.074.01-2	

Compatible with - AVINENT

MODEL	IMPLANT DIAMETER	PLATFORM	(R) NON-ENGAGING (NR) ENGAGING	DYNAMIC ABUTMENT®					
				POM	COBALT-CHROME	DYNAMIC SCREW	ANALOG		
HE	3,3//3,5/4	3,5	R	21.522.023.01-2	21.222.023.01-2	41.318.044.01-2			
	3,3//3,5/4	3,5	NR	21.512.023.01-2	21.212.023.01-2	41.318.044.01-2			
	3,3/3,8/4/4,2/4,8//4,5/5	4,1	R	21.523.024.01-2	21.223.024.01-2	41.320.060.01-2	22.613.024.01-2		
	3,3/3,8/4/4,2/4,8//4,5/5	4,1	NR	21.513.024.01-2	21.213.024.01-2	41.320.060.01-2	22.613.024.01-2		
	4,8	5,1	R	21.524.061.01-2	21.224.061.01-2	41.325.067.01-2	22.614.061.01-2		
	4,8	5,1	NR	21.514.061.01-2	21.214.061.01-2	41.325.067.01-2	22.614.061.01-2		
HI	3,1//3,5/4	3,5	R	21.522.040.01-2	21.222.040.01-2	41.317.071.01-2	22.612.040.01-2		
	3,1//3,5/4	3,5	NR	21.512.040.01-2	21.212.040.01-2	41.317.071.01-2	22.612.040.01-2		
	3,3/3,8/4/4,2/4,8//4,5/5	4,1	R	21.522.040.01-2	21.222.040.01-2	41.317.071.01-2	22.612.040.01-2		
	3,3/3,8/4/4,2/4,8//4,5/5	4,1	NR	21.512.040.01-2	21.212.040.01-2	41.317.071.01-2	22.612.040.01-2		
Transepithelial		Regular			R	21.523.025.01-2	21.223.025.01-2	41.314.040.01-2	22.613.025.01-2

Compatible with - BEGO

MODEL	IMPLANT DIAMETER	PLATFORM	(R) NON-ENGAGING (NR) ENGAGING	DYNAMIC ABUTMENT®			
				POM	COBALT-CHROME	DYNAMIC SCREW	ANALOG
External Hexagon		Narrow Mini (2,7/2,9/3,1)	R	21.522.009.01-2	21.222.009.01-2	41.316.059.01-2	
		Narrow Mini (2,7/2,9/3,1)	NR	--	21.212.009.01-2	41.316.059.01-2	

Compatible with - BIOGENESIS

MODEL	IMPLANT DIAMETER	PLATFORM	(R) NON-ENGAGING (NR) ENGAGING	DYNAMIC ABUTMENT®			
				POM	COBALT-CHROME	DYNAMIC SCREW	ANALOG
3icon	3,3	Mini (Pink)	R	21.522.023.01-2	21.222.023.01-2	41.316.059.01-2	22.612.023.01-2
	3,3	Mini (Pink)	NR	21.512.023.01-2	21.212.023.01-2	41.316.059.01-2	22.612.023.01-2
	3,75/4/4,3/4,5	Regular (Blue)	R	21.523.024.01-2	21.223.024.01-2	41.320.060.01-2	22.613.024.01-2
	3,75/4/4,3/4,5	Regular (Blue)	NR	21.513.024.01-2	21.213.024.01-2	41.320.060.01-2	22.613.024.01-2
	5/5,5	Wide (Yellow)	R	21.524.058.01-2		41.320.047.01-2	22.614.058.01-2
	5/5,5	Wide (Yellow)	NR	21.514.058.01-2		41.320.047.01-2	22.614.058.01-2
Aticon (Cone 20°)		Regular/Wide	R	21.523.066.01-2		41.314.040.01-2	
Aticon (Cone 45°)		Regular/Wide	R	21.523.067.01-2		41.314.040.01-2	
Iticon	3,5/4,1/4,8	4,8	R*	21.523.074.01-2		41.320.050.01-2	22.613.074.01-2
	3,5/4,1/4,8	4,8	NR*	21.513.074.01-2		41.320.050.01-2	22.613.074.01-2

*Converter needed for this compatibility:
Screwdriver converter: 43.601.107.01-2

Compatible with - BIOHORIZON

MODEL	IMPLANT DIAMETER	PLATFORM	(R) NON-ENGAGING (NR) ENGAGING	DYNAMIC ABUTMENT®			
				POM	COBALT-CHROME	DYNAMIC SCREW	ANALOG
External	3,5	3,7 (Yellow)	R	21.522.023.01-2	21.222.023.01-2	41.318.065.01-2	
	3,5	3,7 (Yellow)	NR	21.512.023.01-2	21.212.023.01-2	41.318.065.01-2	
	5	5,2 (Blue)	R	21.524.060.01-2		41.320.060.01-2	
Tapered Internal	3/3,8/4,6	3,5 (Yellow)	R	21.522.040.01-2	21.222.040.01-2	41.317.071.01-2	22.612.040.01-2
	3/3,8/4,6	3,5 (Yellow)	NR	21.512.040.01-2	21.212.040.01-2	41.317.071.01-2	22.612.040.01-2
	4,6/5,8	4,5 (Green)	R	21.523.041.01-2	21.223.041.01-2	41.317.071.01-2	22.613.041.01-2
	4,6/5,8	4,5 (Green)	NR	21.513.041.01-2	21.213.041.01-2	41.317.071.01-2	22.613.041.01-2
Internal	3,5/4	3,5 (Yellow)	R	21.522.040.01-2	21.222.040.01-2	41.317.071.01-2	22.612.040.01-2
	3,5/4	3,5 (Yellow)	NR	21.512.040.01-2	21.212.040.01-2	41.317.071.01-2	22.612.040.01-2
	4/5	4,5 (Green)	R	21.523.041.01-2	21.223.041.01-2	41.317.071.01-2	22.613.041.01-2
	4/5	4,5 (Green)	NR	21.513.041.01-2	21.213.041.01-2	41.317.071.01-2	22.613.041.01-2

Compatible with - BIOCONCEPT

MODEL	IMPLANT DIAMETER	PLATFORM	(R) NON-ENGAGING (NR) ENGAGING	DYNAMIC ABUTMENT®			
				POM	COBALT-CHROME	DYNAMIC SCREW	ANALOG
BV Tapered Bone Level	3,5	Narrow	R	--	21.222.029.01-2	41.316.088.01-2	
	3,5	Narrow	NR	--	21.212.029.01-2	41.316.088.01-2	

Compatible with - BIOMET 3i

MODEL	IMPLANT DIAMETER	PLATFORM	(R) NON-ENGAGING (NR) ENGAGING	DYNAMIC ABUTMENT®			
				POM	COBALT-CHROME	DYNAMIC SCREW	ANALOG
Osseotite	3,25	3,4	R	21.522.003.01-2	21.222.003.01-2	41.320.065.01-2	22.612.003.01-2
	3,25	3,4	NR	21.512.003.01-2	21.212.003.01-2	41.320.065.01-2	22.612.003.01-2
	4	4,1	R	21.523.024.01-2	21.223.024.01-2	41.320.060.01-2	22.613.024.01-2
	4	4,1	NR	21.513.024.01-2	21.213.024.01-2	41.320.060.01-2	22.613.024.01-2
	5	5	R	21.524.058.01-2		41.320.047.01-2	22.614.058.01-2
	5	5	NR	21.514.058.01-2		41.320.047.01-2	22.614.058.01-2
Certain	3,25/4	3,4	R	21.522.001.01-2		41.316.084.01-2	22.612.001.01-2
	3,25/4	3,4	NR	21.512.001.01-2	21.212.001.01-2	41.316.084.01-2	22.612.001.01-2
	4/5	4,1	R	21.523.002.01-2	21.223.002.01-2	41.316.084.01-2	22.613.002.01-2
	4/5	4,1	NR	21.513.002.01-2	21.213.002.01-2	41.316.084.01-2	22.613.002.01-2
Low Pr		Universal	R	21.523.025.01-2	21.223.025.01-2	41.314.040.01-2	22.613.025.01-2

Compatible with - BIOLOK

MODEL	IMPLANT DIAMETER	PLATFORM	(R) NON-ENGAGING (NR) ENGAGING	DYNAMIC ABUTMENT®			
				POM	COBALT-CHROME	DYNAMIC SCREW	ANALOG
External Hexagon	3,45	3,45	R	21.522.003.01-2	21.222.003.01-2	41.320.065.01-2	22.612.003.01-2
	3,45	3,45	NR	21.512.003.01-2	21.212.003.01-2	41.320.065.01-2	22.612.003.01-2

Compatible with - BIONER

MODEL	IMPLANT DIAMETER	PLATFORM	(R) NON-ENGAGING (NR) ENGAGING	DYNAMIC ABUTMENT®			
				POM	COBALT-CHROME	DYNAMIC SCREW	ANALOG
Ikelt / Bikelt	3,3/3,75/4	4,1	R	21.523.024.01-2	21.223.024.01-2	41.320.060.01-2	22.613.024.01-2
	3,3/3,75/4	4,1	NR	21.513.024.01-2	21.213.024.01-2	41.320.060.01-2	22.613.024.01-2
Ikelt	5	5	R	21.524.058.01-2		41.320.047.01-2	22.614.058.01-2
	5	5	NR	21.514.058.01-2		41.320.047.01-2	22.614.058.01-2
Hikelt	3,8	3,95	R	21.522.040.01-2	21.222.040.01-2	41.317.071.01-2	22.612.040.01-2
	3,8	3,95	NR	21.512.040.01-2	21.212.040.01-2	41.317.071.01-2	22.612.040.01-2
	4,7	4,9	R	21.523.041.01-2	21.223.041.01-2	41.317.071.01-2	22.613.041.01-2
	4,7	4,9	NR	21.513.041.01-2	21.213.041.01-2	41.317.071.01-2	22.613.041.01-2
TopDM	3,5	3,5	R	21.522.021.01-2	21.222.021.01-2	41.316.073.01-2	22.612.021.01-2
	3,5	3,5	NR	21.512.021.01-2	21.212.021.01-2	41.316.073.01-2	22.612.021.01-2
	4	4	R	21.522.021.01-2	21.222.021.01-2	41.316.073.01-2	22.612.021.01-2
	4	4	NR	21.512.021.01-2	21.212.021.01-2	41.316.073.01-2	22.612.021.01-2
	5	5	R	21.522.021.01-2	21.222.021.01-2	41.316.073.01-2	22.612.021.01-2
	5	5	NR	21.512.021.01-2	21.212.021.01-2	41.316.073.01-2	22.612.021.01-2
Transepithelial A-5M		Regular	R	21.523.025.01-2	21.223.025.01-2	41.314.040.01-2	22.613.025.01-2

Compatible with - BIOTEC

MODEL	IMPLANT DIAMETER	PLATFORM	(R) NON-ENGAGING (NR) ENGAGING	DYNAMIC ABUTMENT®			
				POM	COBALT-CHROME	DYNAMIC SCREW	ANALOG
SPR/CIM	3,3	3,3	R	21.522.040.01-2	21.222.040.01-2	41.317.071.01-2	22.612.040.01-2
	3,3	3,3	NR	21.512.040.01-2	21.212.040.01-2	41.317.071.01-2	22.612.040.01-2
	3,75	3,75	R	21.522.040.01-2	21.222.040.01-2	41.317.071.01-2	22.612.040.01-2
	3,75	3,75	NR	21.512.040.01-2	21.212.040.01-2	41.317.071.01-2	22.612.040.01-2
SPR/SPTT /CIM	4,2	4,2	R	21.522.040.01-2	21.222.040.01-2	41.317.071.01-2	22.612.040.01-2
	4,2	4,2	NR	21.512.040.01-2	21.212.040.01-2	41.317.071.01-2	22.612.040.01-2
	5	5	R	21.522.040.01-2	21.222.040.01-2	41.317.071.01-2	22.612.040.01-2
	5	5	NR	21.512.040.01-2	21.212.040.01-2	41.317.071.01-2	22.612.040.01-2

Compatible with - BIOTECH

MODEL	IMPLANT DIAMETER	PLATFORM	(R) NON-ENGAGING (NR) ENGAGING	DYNAMIC ABUTMENT®			
				POM	COBALT-CHROME	DYNAMIC SCREW	ANALOG
Smilea / Smilea Conic External		Narrow (3,6)	R	21.522.023.01-2	21.222.023.01-2	41.320.065.01-2	

Compatible with - BTI

MODEL	IMPLANT DIAMETER	PLATFORM	(R) NON-ENGAGING (NR) ENGAGING	DYNAMIC ABUTMENT®			
				POM	COBALT-CHROME	DYNAMIC SCREW	ANALOG
External Connection Tiny	2,5/3/3,3/3,5/3,75	Tiny 3,5	R	21.522.009.01-2	21.222.009.01-2	41.320.051.01-2	
	2,5/3/3,3/3,5/3,75	Tiny 3,5	NR		21.212.009.01-2	41.320.051.01-2	
External Connection	3,75/4/4,5/5	Universal 4,1	R	21.523.024.01-2	21.223.024.01-2	41.320.060.01-2	22.613.024.01-2
	3,75/4/4,5/5	Universal 4,1	NR	21.513.024.01-2	21.213.024.01-2	41.320.060.01-2	22.613.024.01-2
	4,5/5/5,5	Ancha 5,5	R	21.524.060.01-2		41.320.060.01-2	22.614.060.01-2
	4,5/5/5,5	Ancha 5,5	NR	21.514.060.01-2		41.320.060.01-2	22.614.060.01-2
Internal Connection	3,3/3,5/3,75/4/4,25/5/5,5	Universal 4,1	R	21.523.010.01-2	21.223.010.01-2	41.318.075.01-2	22.613.010.01-2
	3,3/3,5/3,75/4/4,25/5/5,5	Universal 4,1	NR	21.513.010.01-2		41.318.075.01-2	22.613.010.01-2

Compatible with - BTK

MODEL	IMPLANT DIAMETER	PLATFORM	(R) NON-ENGAGING (NR) ENGAGING	DYNAMIC ABUTMENT®			
				POM	COBALT-CHROME	DYNAMIC SCREW	ANALOG
Klassic / Konic	3,25	3,4 EN	R	21.522.003.01-2	21.222.003.01-2	41.318.065.01-2	
	3,25	3,4 EN	NR	21.512.003.01-2	21.212.003.01-2	41.318.065.01-2	
	3,25PL/3,75/4	4,1 ER	R	21.523.024.01-2	21.223.024.01-2	41.320.060.01-2	22.613.024.01-2
	3,25PL/3,75/4	4,1 ER	NR	21.513.024.01-2	21.213.024.01-2	41.320.060.01-2	22.613.024.01-2
	3,25/4	3,5 IR	R	21.522.040.01-2	21.222.040.01-2	41.317.071.01-2	22.612.040.01-2
	3,25/4	3,5 IR	NR	21.512.040.01-2	21.212.040.01-2	41.317.071.01-2	22.612.040.01-2
	3,25/4	3,5 IR	NR (ZIO)	21.512.042.01-2	21.212.042.01-2	41.317.071.01-2	22.612.040.01-2

Compatible with - B&W

MODEL	IMPLANT DIAMETER	PLATFORM	(R) NON-ENGAGING (NR) ENGAGING	DYNAMIC ABUTMENT®			
				POM	COBALT-CHROME	DYNAMIC SCREW	ANALOG
External Hexagon	3,25/3,3	3,3	R		21.212.023.01-2	41.317.071.01-2	
	3,25/3,3	3,3	NR	21.522.023.01-2	21.222.023.01-2	41.317.071.01-2	
	3,75/4	4,1	R	21.523.024.01-2	21.223.024.01-2	41.320.060.01-2	22.613.024.01-2
	3,75/4	4,1	NR	21.513.024.01-2	21.213.024.01-2	41.320.060.01-2	22.613.024.01-2
	5	5	R	21.524.058.01-2		41.320.047.01-2	22.614.058.01-2
	5	5	NR	21.514.058.01-2		41.320.047.01-2	22.614.058.01-2

Compatible with - CONEXÃO SISTEMA DE PRÓTESE

MODEL	IMPLANT DIAMETER	PLATFORM	(R) NON-ENGAGING (NR) ENGAGING	DYNAMIC ABUTMENT®			
				POM	COBALT-CHROME	DYNAMIC SCREW	ANALOG
Flash	3,5/4,3/5	Universal	R	21.522.021.01-2	21.222.021.01-2	41.316.073.01-2	22.612.021.01-2
	3,5/4,3/5	Universal	NR	21.512.021.01-2	21.212.021.01-2	41.316.073.01-2	22.612.021.01-2
Torq	3,5/3,75/4	Universal	R	21.522.021.01-2	21.222.021.01-2	41.316.073.01-2	22.612.021.01-2
	3,5/3,75/4	Universal	NR	21.512.021.01-2	21.212.021.01-2	41.316.073.01-2	22.612.021.01-2
Expand	3,75/4/5	Universal	R	21.522.021.01-2	21.222.021.01-2	41.316.073.01-2	22.612.021.01-2
	3,75/4/5	Universal	NR	21.512.021.01-2	21.212.021.01-2	41.316.073.01-2	22.612.021.01-2

Compatible with - CORTEX

MODEL	IMPLANT DIAMETER	PLATFORM	(R) NON-ENGAGING (NR) ENGAGING	DYNAMIC ABUTMENT®			
				POM	COBALT-CHROME	DYNAMIC SCREW	ANALOG
Dynamix	3,3/3,8/4,2/5/6	3,75	R	21.522.040.01-2	21.222.040.01-2	41.317.071.01-2	22.612.040.01-2
	3,3/3,8/4,2/5/6	3,75	NR	21.512.040.01-2	21.212.040.01-2	41.317.071.01-2	22.612.040.01-2
Classix	3,3/3,8/4,2/5/6	3,75	R	21.522.040.01-2	21.222.040.01-2	41.317.071.01-2	22.612.040.01-2
	3,3/3,8/4,2/5/6	3,75	NR	21.512.040.01-2	21.212.040.01-2	41.317.071.01-2	22.612.040.01-2
Saturn	3,8/4,2	3,5	R	21.522.040.01-2	21.222.040.01-2	41.317.071.01-2	22.612.040.01-2
	3,8/4,2	3,5	NR	21.512.040.01-2	21.212.040.01-2	41.317.071.01-2	22.612.040.01-2

Compatible with - DENTAL TECH

MODEL	IMPLANT DIAMETER	PLATFORM	(R) NON-ENGAGING (NR) ENGAGING	DYNAMIC ABUTMENT®			
				POM	COBALT-CHROME	DYNAMIC SCREW	ANALOG
Implogic	4,5	4,5 (Blue)	R	21.523.041.01-2	21.223.041.01-2	41.317.071.01-2	22.613.041.01-2
	4,5	4,5 (Blue)	NR	21.513.041.01-2	21.213.041.01-2	41.317.071.01-2	22.613.041.01-2

Compatible with - DENTIS

MODEL	IMPLANT DIAMETER	PLATFORM	(R) NON-ENGAGING (NR) ENGAGING	DYNAMIC ABUTMENT®			
				POM	COBALT-CHROME	DYNAMIC SCREW	ANALOG
s-Clean*	3,7	Mini	R	21.523.030.01-2	21.223.030.01-2	41.320.079.01-2	
	3,7	Mini	NR	21.513.030.01-2	21.213.030.01-2	41.320.079.01-2	
	4,1/4,3	Regular	R	21.523.030.01-2	21.223.030.01-2	41.320.079.01-2	
	4,1/4,3	Regular	NR	21.513.030.01-2	21.213.030.01-2	41.320.079.01-2	
	4,8	Wide	R	21.523.030.01-2	21.223.030.01-2	41.320.079.01-2	
	4,8	Wide	NR	21.513.030.01-2	21.213.030.01-2	41.320.079.01-2	

*Maximum angulation 20°

Compatible with - DENTIUM

MODEL	IMPLANT DIAMETER	PLATFORM	(R) NON-ENGAGING (NR) ENGAGING	DYNAMIC ABUTMENT®			
				POM	COBALT-CHROME	DYNAMIC SCREW	ANALOG
SimpleLine II	3,8/4,3	4,8	R*	21.523.074.01-2		41.320.050.01-2	22.613.074.01-2
	3,8/4,3	4,8	NR*	21.513.074.01-2		41.320.050.01-2	22.613.074.01-2
SuperLine and Implantium* <small>*Maximum angulation 20°</small>	3,4	3,6	R	21.523.030.01-2	21.223.030.01-2	41.320.079.01-2	
	3,4	3,6	NR	21.513.030.01-2	21.213.030.01-2	41.320.079.01-2	
	3,8	4	R	21.523.030.01-2	21.223.030.01-2	41.320.079.01-2	
	3,8	4	NR	21.513.030.01-2	21.213.030.01-2	41.320.079.01-2	
	4,3	4,5	R	21.523.030.01-2	21.223.030.01-2	41.320.079.01-2	
	4,3	4,5	NR	21.513.030.01-2	21.213.030.01-2	41.320.079.01-2	
	4,8	5	R	21.523.030.01-2	21.223.030.01-2	41.320.079.01-2	
	4,8	5	NR	21.513.030.01-2	21.213.030.01-2	41.320.079.01-2	
	4,8	6	R	21.523.030.01-2	21.223.030.01-2	41.320.079.01-2	
	4,8	6	NR	21.513.030.01-2	21.213.030.01-2	41.320.079.01-2	

*Converter needed for this compatibility:
Screwdriver converter: 43.601.107.01-2

Compatible with - DIO IMPLANTS

MODEL	IMPLANT DIAMETER	PLATFORM	(R) NON-ENGAGING (NR) ENGAGING	DYNAMIC ABUTMENT®			
				POM	COBALT-CHROME	DYNAMIC SCREW	ANALOG
SM System	3,8/4,1	Narrow	R	21.522.076.01-2	21.222.076.01-2	41.318.075.01-2	
	3,8/4,1	Narrow	NR		21.212.076.01-2	41.318.075.01-2	
	4,5/5/5,3	Regular/	R	21.523.013.01-2	21.223.013.01-2	41.320.074.01-2	
	4,5/5/5,3	Regular/	NR		21.213.013.01-2	41.320.074.01-2	
Narrow Fix	3,3/3,6	Narrow			21.212.009.01-2	41.316.044.01-2	
	3,3/3,6	Narrow			21.212.009.01-2	41.316.044.01-2	
UF II Narrow	3/3,3	Narrow	R	21.522.014.01-2	21.222.014.01-2	41.314.067.01-2	
	3/3,3	Narrow	NR	21.512.014.01-2	21.212.014.01-2	41.314.067.01-2	
UF II* <small>*Maximum angulation 20°</small>	3,8/4/4,5/5/5,5	Regular	R	21.523.030.01-2	21.223.030.01-2	41.320.079.01-2	
	3,8/4/4,5/5/5,5	Regular	NR	21.513.030.01-2	21.213.030.01-2	41.320.079.01-2	
External	3,3/3,8	Narrow 3,5	R	21.522.023.01-2	21.222.023.01-2	41.316.059.01-2	22.612.023.01-2
	3,3/3,8	Narrow 3,5	NR	21.512.023.01-2	21.212.023.01-2	41.316.059.01-2	22.612.023.01-2
	3,75/4/4,5	Regular 4,1	R	21.523.024.01-2	21.223.024.01-2	41.320.060.01-2	22.613.024.01-2
	3,75/4/4,5	Regular 4,1	NR	21.513.024.01-2	21.213.024.01-2	41.320.060.01-2	22.613.024.01-2
	5/5,3/5,5/6	Wide 5,1	R	21.524.061.01-2	21.224.061.01-2	41.325.067.01-2	22.614.061.01-2
	5/5,3/5,5/6	Wide 5,1	NR	21.514.061.01-2	21.214.061.01-2	41.325.067.01-2	22.614.061.01-2

Compatible with - DPS BIOMEDICAL

MODEL	IMPLANT DIAMETER	PLAT-FORM	(R) NON-ENGAGING (NR) ENGAGING	DYNAMIC ABUTMENT®			
				POM	COBALT-CHROME	DYNAMIC SCREW	ANALOG
External Hexagon	3,75/4/5//3,5/3,8/4,3	4,1	R	21.523.024.01-2	21.223.024.01-2	41.320.065.01-2	22.613.024.01-2
	3,75/4/5//3,5/3,8/4,3	4,1	NR	21.513.024.01-2	21.213.024.01-2	41.320.065.01-2	22.613.024.01-2

Compatible with - ECKERMAN

MODEL	IMPLANT DIAMETER	PLATFORM	(R) NON-ENGAGING (NR) ENGAGING	DYNAMIC ABUTMENT®			
				POM	COBALT-CHROME	DYNAMIC SCREW	ANALOG
All-Spiral	3/3,5/4/4,5/5	Regular	R			41.318.048.01-2	
	3/3,5/4/4,5/5	Regular	NR			41.318.048.01-2	
Hexagon	3/3,5/4/4,5/5	4,1	R	21.523.024.01-2	21.223.024.01-2	41.320.060.01-2	22.613.024.01-2
	3/3,5/4/4,5/5	4,1	NR	21.513.024.01-2	21.213.024.01-2	41.320.060.01-2	22.613.024.01-2

Compatible with - ELITE MEDICAL

MODEL	IMPLANT DIAMETER	PLATFORM	(R) NON-ENGAGING (NR) ENGAGING	DYNAMIC ABUTMENT®			
				POM	COBALT-CHROME	DYNAMIC SCREW	ANALOG
External Connection		Narrow	R	21.522.023.01-2	21.222.023.01-2	41.316.059.01-2	22.612.023.01-2
		Narrow	NR	21.512.023.01-2	21.212.023.01-2	41.316.059.01-2	22.612.023.01-2
		Regular	R	21.523.024.01-2	21.223.024.01-2	41.320.060.01-2	22.613.024.01-2
		Regular	NR	21.513.024.01-2	21.213.024.01-2	41.320.060.01-2	22.613.024.01-2
		Wide	R	21.524.061.01-2	21.224.061.01-2	41.325.067.01-2	22.614.061.01-2
		Wide	NR	21.514.061.01-2	21.214.061.01-2	41.325.067.01-2	22.614.061.01-2

MODEL	IMPLANT DIAMETER	PLATFORM	(R) NON-ENGAGING (NR) ENGAGING	DYNAMIC ABUTMENT®				
				POM	COBALT-CHROME	DYNAMIC SCREW	ANALOG	
Naturactis	3,5	3,4	R	21.523.004.01-2	21.223.004.01-2	41.316.076.01-2	22.613.004.01-2	
	3,5	3,4	NR	21.513.004.01-2	21.213.004.01-2	41.316.076.01-2	22.613.004.01-2	
	4	3,8	R	21.523.004.01-2	21.223.004.01-2	41.316.076.01-2	22.613.004.01-2	
	4	3,8	NR	21.513.004.01-2	21.213.004.01-2	41.316.076.01-2	22.613.004.01-2	
	4,5	4,3	R	21.523.004.01-2	21.223.004.01-2	41.316.076.01-2	22.613.004.01-2	
	4,5	4,3	NR	21.513.004.01-2	21.213.004.01-2	41.316.076.01-2	22.613.004.01-2	
	5	4,8	R	21.523.004.01-2	21.223.004.01-2	41.316.076.01-2	22.613.004.01-2	
	5	4,8	NR	21.513.004.01-2	21.213.004.01-2	41.316.076.01-2	22.613.004.01-2	
	Uneva	3,6	4,1	R	21.523.024.01-2	21.223.024.01-2	41.320.060.01-2	22.613.024.01-2
		3,6	4,1	NR	21.513.024.01-2	21.213.024.01-2	41.320.060.01-2	22.613.024.01-2
4,1		4,1	R	21.523.024.01-2	21.223.024.01-2	41.320.060.01-2	22.613.024.01-2	
4,1		4,1	NR	21.513.024.01-2	21.213.024.01-2	41.320.060.01-2	22.613.024.01-2	
Uneva (Platform Switching)	4,8	4,1	R	21.523.024.01-2	21.223.024.01-2	41.320.060.01-2		
	4,8	4,1	NR	21.513.024.01-2	21.213.024.01-2	41.320.060.01-2		
	6	4,1	R	21.523.024.01-2	21.223.024.01-2	41.320.060.01-2		
Natea	6	4,1	NR	21.513.024.01-2	21.213.024.01-2	41.320.060.01-2		
	3,6/4,1/4,8	Narrow	R	21.523.004.01-2	21.223.004.01-2	41.316.076.01-2	22.613.004.01-2	
	3,6/4,1/4,8	Narrow	NR	21.513.004.01-2	21.213.004.01-2	41.316.076.01-2	22.613.004.01-2	
	3,6/4,1/4,8	Regular	R	21.523.004.01-2	21.223.004.01-2	41.316.076.01-2	22.613.004.01-2	
	3,6/4,1/4,8	Regular	NR	21.513.004.01-2	21.213.004.01-2	41.316.076.01-2	22.613.004.01-2	

MODEL	IMPLANT DIAMETER	PLATFORM	(R) NON-ENGAGING (NR) ENGAGING	DYNAMIC ABUTMENT®			
				POM	COBALT-CHROME	DYNAMIC SCREW	ANALOG
Aesthetica	4,1	4,8	R*	21.523.074.01-2		41.320.050.01-2	22.613.074.01-2
	4,1	4,8	NR*	21.513.074.01-2		41.320.050.01-2	22.613.074.01-2
Naturall	3,5	Narrow	R	21.523.004.01-2	21.223.004.01-2	41.316.076.01-2	22.613.004.01-2
	3,5	Narrow	NR	21.513.004.01-2	21.213.004.01-2	41.316.076.01-2	22.613.004.01-2
	4/4,5	Regular	R	21.523.004.01-2	21.223.004.01-2	41.316.076.01-2	22.613.004.01-2
	4/4,5	Regular	NR	21.513.004.01-2	21.213.004.01-2	41.316.076.01-2	22.613.004.01-2

Screwdriver converter: 43.601.107.01-2

Compatible with - GALIMPLANT

MODEL	IMPLANT DIAMETER	PLATFORM	(R) NON-ENGAGING (NR) ENGAGING	DYNAMIC ABUTMENT®			
				POM	COBALT-CHROME	DYNAMIC SCREW	ANALOG
External Connection	3,5/4	4	R	21.523.024.01-2	21.223.024.01-2	41.320.065.01-2	22.613.024.01-2
	3,5/4	4	NR	21.513.024.01-2	21.213.024.01-2	41.320.065.01-2	22.613.024.01-2
Internal Connection	4	4	R	21.523.004.01-2	21.223.004.01-2	41.316.076.01-2	22.613.004.01-2
	4	4	NR	21.513.004.01-2	21.213.004.01-2	41.316.076.01-2	22.613.004.01-2

Compatible with - GMI (ILERIMPLANT)

MODEL	IMPLANT DIAMETER	PLATFORM	(R) NON-ENGAGING (NR) ENGAGING	DYNAMIC ABUTMENT®			
				POM	COBALT-CHROME	DYNAMIC SCREW	ANALOG
Phoenix	3,3	Narrow 3,3	R		21.222.023.01-2	41.318.044.01-2	
	3,3	Narrow 3,3	NR		21.212.023.01-2	41.318.044.01-2	
	3,3/3,75/4	Standard 4,1	R	21.523.024.01-2	21.223.024.01-2	41.320.060.01-2	22.613.024.01-2
	3,3/3,75/4	Standard 4,1	NR	21.513.024.01-2	21.213.024.01-2	41.320.060.01-2	22.613.024.01-2
	5	Wide 5,1	R	21.524.061.01-2	21.224.061.01-2	41.325.067.01-2	22.614.061.01-2
	5	Wide 5,1	NR	21.514.061.01-2	21.214.061.01-2	41.325.067.01-2	22.614.061.01-2
Frontier	3,3/3,75/4,25	RP 3,3	R	21.522.040.01-2	21.222.040.01-2	41.318.075.01-2	
	3,3/3,75/4,25	RP 3,3	NR	21.512.040.01-2	21.212.040.01-2	41.318.075.01-2	
	4,75/5,75	WP 4,3	R	21.523.041.01-2	21.223.041.01-2	41.318.075.01-2	
	4,75/5,75	WP 4,3	NR	21.513.041.01-2	21.213.041.01-2	41.318.075.01-2	

Compatible with - GT MEDICAL

MODEL	IMPLANT DIAMETER	PLATFORM	(R) NON-ENGAGING (NR) ENGAGING	DYNAMIC ABUTMENT®			
				POM	COBALT-CHROME	DYNAMIC SCREW	ANALOG
Best Fit Internal Octagon	3,7/4,3/4,8	Regular	R*	21.523.074.01-2		41.320.050.01-2	22.613.074.01-2
	3,7/4,3/4,8	Regular	NR*	21.513.074.01-2		41.320.050.01-2	22.613.074.01-2
Best Fit External Hexagon	3,5	Narrow	R	21.522.023.01-2	21.222.023.01-2	41.316.059.01-2	22.612.023.01-2
	3,5	Narrow	NR	21.512.023.01-2	21.212.023.01-2	41.316.059.01-2	22.612.023.01-2
	4,1	Regular	R	21.523.024.01-2	21.223.024.01-2	41.320.060.01-2	22.613.024.01-2
	4,1	Regular	NR	21.513.024.01-2	21.213.024.01-2	41.320.060.01-2	22.613.024.01-2
	5,1	Wide	R	21.524.061.01-2	21.224.061.01-2	41.325.067.01-2	22.614.061.01-2
5,1	Wide	NR	21.514.061.01-2	21.214.061.01-2	41.325.067.01-2	22.614.061.01-2	

*Converter needed for this compatibility:
Screwdriver converter: 43.601.107.01-2

Compatible with - HI-TEC

MODEL	IMPLANT DIAMETER	PLATFORM	(R) NON-ENGAGING (NR) ENGAGING	DYNAMIC ABUTMENT®			
				POM	COBALT-CHROME	DYNAMIC SCREW	ANALOG
Tapered Self Thread	3,3/3,75	3,5	R	21.522.040.01-2	21.222.040.01-2	41.317.071.01-2	22.612.040.01-2
	3,3/3,75	3,5	NR	21.512.040.01-2	21.212.040.01-2	41.317.071.01-2	22.612.040.01-2
	4,2/5	4,5	R	21.523.041.01-2	21.223.041.01-2	41.317.071.01-2	22.613.041.01-2
	4,2/5	4,5	NR	21.513.041.01-2	21.213.041.01-2	41.317.071.01-2	22.613.041.01-2
Logic Plus	3,5	3,7	R	21.522.040.01-2	21.222.040.01-2	41.317.071.01-2	22.612.040.01-2
	3,5	3,7	NR	21.512.040.01-2	21.212.040.01-2	41.317.071.01-2	22.612.040.01-2
	4,3	3,9	R	21.522.040.01-2	21.222.040.01-2	41.317.071.01-2	22.612.040.01-2
	4,3	3,9	NR	21.512.040.01-2	21.212.040.01-2	41.317.071.01-2	22.612.040.01-2

Compatible with -HIOSEN

MODEL	IMPLANT DIAMETER	PLATFORM	(R) NON-ENGAGING (NR) ENGAGING	DYNAMIC ABUTMENT®			
				POM	COBALT-CHROME	DYNAMIC SCREW	ANALOG
ETII SA / ETIII SA	3,5	Mini	R	--	21.222.029.01-2	41.316.088.01-2	
	3,5	Mini	NR	--	21.212.029.01-2	41.316.088.01-2	
ETIII BA	3,5	Mini	R	--	21.212.029.01-2	41.316.088.01-2	
	3,5	Mini	NR	--	21.222.029.01-2	41.316.088.01-2	

Compatible with - IHDE DENTAL (IMBIODENT)

MODEL	IMPLANT DIAMETER	PLATFORM	(R) NON-ENGAGING (NR) ENGAGING	DYNAMIC ABUTMENT®			
				POM	COBALT-CHROME	DYNAMIC SCREW	ANALOG
Bone Level Plus	3,3	3,3	R	21.522.033.01-2	21.222.033.01-2	41.316.078.01-2	22.612.033.01-2
	3,3	3,3	NR	21.512.033.01-2	21.212.033.01-2	41.316.078.01-2	22.612.033.01-2
	4,1	4,1	R	21.523.035.01-2	21.223.035.01-2	41.316.078.01-2	22.613.035.01-2
	4,1	4,1	NR	21.513.035.01-2	21.213.035.01-2	41.316.078.01-2	22.613.035.01-2
	4,8	4,8	R	21.523.035.01-2	21.223.035.01-2	41.316.078.01-2	22.613.035.01-2
	4,8	4,8	NR	21.513.035.01-2	21.213.035.01-2	41.316.078.01-2	22.613.035.01-2

Compatible with - IMPLANT DIRECT

MODEL	IMPLANT DIAMETER	PLATFORM	(R) NON-ENGAGING (NR) ENGAGING	DYNAMIC ABUTMENT®			
				POM	COBALT-CHROME	DYNAMIC SCREW	ANALOG
RePlus / Replant / Reactive	3,5/3,7/4,2	3,5	R	21.522.026.01-2	21.222.026.01-2	41.318.075.01-2	22.612.026.01-2
	3,5/3,7/4,2	3,5	NR	21.512.026.01-2	21.212.026.01-2	41.318.075.01-2	22.612.026.01-2
	4,3/4,7	4,3	R	21.523.027.01-2	21.223.027.01-2	41.320.082.01-2	22.613.027.01-2
	4,3/4,7	4,3	NR	21.513.027.01-2	21.213.027.01-2	41.320.082.01-2	22.613.027.01-2
Legacy	3,7	3,5	R	21.522.040.01-2	21.222.040.01-2	41.317.071.01-2	22.612.040.01-2
	3,7	3,5	NR	21.512.040.01-2	21.212.040.01-2	41.317.071.01-2	22.612.040.01-2
	4,7	4,5	R	21.523.041.01-2	21.223.041.01-2	41.317.071.01-2	22.613.041.01-2
	4,7	4,5	NR	21.513.041.01-2	21.213.041.01-2	41.317.071.01-2	22.613.041.01-2
SwishActive	3,3	3	R	21.522.021.01-2	21.222.021.01-2	41.316.073.01-2	22.612.021.01-2
	3,3	3	NR	21.512.021.01-2	21.212.021.01-2	41.316.073.01-2	22.612.021.01-2
	4,1/4,8	3,4	R	21.523.022.01-2	21.223.022.01-2	41.320.075.01-2	22.613.022.01-2
	4,1/4,8	3,4	NR	21.513.022.01-2	21.213.022.01-2	41.320.075.01-2	22.613.022.01-2
Interactive	3,2/3,7	3	R	21.522.021.01-2	21.222.021.01-2	41.316.073.01-2	22.612.021.01-2
	3,2/3,7	3	NR	21.512.021.01-2	21.212.021.01-2	41.316.073.01-2	22.612.021.01-2
	4,3/5	3,4	R	21.523.022.01-2	21.223.022.01-2	41.320.075.01-2	22.613.022.01-2
	4,3/5	3,4	NR	21.513.022.01-2	21.213.022.01-2	41.320.075.01-2	22.613.022.01-2

Compatible with - JDENTALCARE

MODEL	IMPLANT DIAMETER	PLATFORM	(R) NON-ENGAGING (NR) ENGAGING	DYNAMIC ABUTMENT®			
				POM	COBALT-CHROME	DYNAMIC SCREW	ANALOG
JDEvolution/ JDEvolution Plus	3,7	3,7	R	21.522.040.01-2	21.222.040.01-2	41.317.071.01-2	22.612.040.01-2
	3,7	3,7	NR	21.512.040.01-2	21.212.040.01-2	41.317.071.01-2	22.612.040.01-2
	4,3/5	4	R	21.522.040.01-2	21.222.040.01-2	41.317.071.01-2	22.612.040.01-2
	4,3/5	4	NR	21.512.040.01-2	21.212.040.01-2	41.317.071.01-2	22.612.040.01-2
	6	5	R	21.522.040.01-2	21.222.040.01-2	41.317.071.01-2	22.612.040.01-2
	6	5	NR	21.512.040.01-2	21.212.040.01-2	41.317.071.01-2	22.612.040.01-2

Compatible with - KEYSTONE

MODEL	IMPLANT DIAMETER	PLATFORM	(R) NON-ENGAGING (NR) ENGAGING	DYNAMIC ABUTMENT®			
				POM	COBALT-CHROME	DYNAMIC SCREW	ANALOG
Restore	3,3	SD 3,3	R	21.522.023.01-2	21.222.023.01-2	41.318.044.01-2	
	3,3	SD 3,3	NR	21.512.023.01-2	21.212.023.01-2	41.318.044.01-2	
	3,75/4	RD 4,1	R	21.523.024.01-2	21.223.024.01-2	41.320.060.01-2	22.613.024.01-2
	3,75/4	RD 4,1	NR	21.513.024.01-2	21.213.024.01-2	41.320.060.01-2	22.613.024.01-2
	5/6	WD 5	R	21.524.061.01-2	21.224.061.01-2	41.325.054.01-2	
Internal TiLobe Prima Connex	3,3/3,5	3,5	R			41.318.065.01-2	
	3,3/3,5	3,5	NR			41.318.065.01-2	
	4/4,1	4,1	R			41.318.065.01-2	
	4/4,1	4,1	NR			41.318.065.01-2	
	5	5	R			41.318.065.01-2	
	5	5	NR			41.318.065.01-2	

Compatible with - KLOCKNER

MODEL	IMPLANT DIAMETER	PLATFORM	(R) NON-ENGAGING (NR) ENGAGING	DYNAMIC ABUTMENT®			
				POM	COBALT-CHROME	DYNAMIC SCREW	ANALOG
NK2-SK2	3,3/3,8/4,2	4,2	R	21.523.062.01-2		41.318.044.01-2	
	3,3/3,8/4,2	4,2	NR			41.318.044.01-2	
Essential Cone*	3,5/4/4,5	4,5	R	21.523.054.01-2		41.318.048.01-2	
	3,5/4/4,5	4,5	NR			41.318.048.01-2	
KL	3,5	Narrow	R	21.522.023.01-2	21.222.023.01-2	41.316.059.01-2	22.612.023.01-2
	3,5	Narrow	NR	21.512.023.01-2	21.212.023.01-2	41.316.059.01-2	22.612.023.01-2
	4,1	Regular	R	21.523.024.01-2	21.223.024.01-2	41.320.060.01-2	22.613.024.01-2
	4,1	Regular	NR	21.513.024.01-2	21.213.024.01-2	41.320.060.01-2	22.613.024.01-2
	5,1	Wide	R	21.524.061.01-2	21.224.061.01-2	41.325.067.01-2	22.614.061.01-2
	5,1	Wide	NR	21.514.061.01-2	21.214.061.01-2	41.325.067.01-2	22.614.061.01-2

*Compatible with Octacone12°

Compatible with - LEADER

MODEL	IMPLANT DIAMETER	PLATFORM	(R) NON-ENGAGING (NR) ENGAGING	DYNAMIC ABUTMENT®			
				POM	COBALT-CHROME	DYNAMIC SCREW	ANALOG
Tixos Internal Hex	3,3	3,5	R	21.522.040.01-2	21.222.040.01-2	41.317.071.01-2	22.612.040.01-2
	3,3	3,5	NR	21.512.040.01-2	21.212.040.01-2	41.317.071.01-2	22.612.040.01-2
	3,75	4	R	21.522.040.01-2	21.222.040.01-2	41.317.071.01-2	22.612.040.01-2
	3,75	4	NR	21.512.040.01-2	21.212.040.01-2	41.317.071.01-2	22.612.040.01-2
Tixos External Hex	3,3/3,75	4,1	R	21.523.024.01-2	21.223.024.01-2	41.320.060.01-2	22.613.024.01-2
	3,3/3,75	4,1	NR	21.513.024.01-2	21.213.024.01-2	41.320.060.01-2	22.613.024.01-2
	5	5	R	21.524.058.01-2		41.320.060.01-2	22.614.058.01-2
	5	5	NR	21.514.058.01-2		41.320.060.01-2	22.614.058.01-2

Compatible with - MEGAGEN

MODEL	IMPLANT DIAMETER	PLATFORM	(R) NON-ENGAGING (NR) ENGAGING	DYNAMIC ABUTMENT®			
				POM	COBALT-CHROME	DYNAMIC SCREW	ANALOG
AnyRidge	3,5	Small	R	21.523.015.01-2	21.223.015.01-2	41.318.075.01-2	
	3,5	Small	NR	21.513.015.01-2	21.213.015.01-2	41.318.075.01-2	
	4/4,5	Regular	R	21.523.015.01-2	21.223.015.01-2	41.318.075.01-2	
	4/4,5	Regular	NR	21.513.015.01-2	21.213.015.01-2	41.318.075.01-2	
	5/5,5	Wide	R	21.523.015.01-2	21.223.015.01-2	41.318.075.01-2	
	5/5,5	Wide	NR	21.513.015.01-2	21.213.015.01-2	41.318.075.01-2	
AnyOne Internal*	3,5/4/4,5/5/6/7	General	R	21.523.030.01-2	21.223.030.01-2	41.320.079.01-2	
	3,5/4/4,5/5/6/7	General	NR	21.513.030.01-2	21.213.030.01-2	41.320.079.01-2	
AnyOne External	3,5	Small 3,5	R	21.522.023.01-2	21.222.023.01-2	41.316.059.01-2	22.612.023.01-2
	3,5	Small 3,5	NR	21.512.023.01-2	21.212.023.01-2	41.316.059.01-2	22.612.023.01-2
	4	Regular 4,1	R	21.523.024.01-2	21.223.024.01-2	41.320.060.01-2	22.613.024.01-2
	4	Regular 4,1	NR	21.513.024.01-2	21.213.024.01-2	41.320.060.01-2	22.613.024.01-2
	5	Wide 5	R	21.524.058.01-2		41.320.065.01-2	22.614.058.01-2
	5	Wide 5	NR	21.514.058.01-2		41.320.065.01-2	22.614.058.01-2
	6	SuperWide 5,5	R	21.524.058.01-2		41.320.065.01-2	22.614.058.01-2
	6	SuperWide 5,5	NR	21.514.058.01-2		41.320.065.01-2	22.614.058.01-2
Mini	3/3,4	Mini 3/3,25	R	21.522.014.01-2	21.222.014.01-2	41.314.067.01-2	
	3/3,4	Mini 3/3,25	NR	21.512.014.01-2	21.212.014.01-2	41.314.067.01-2	

*Maximum angulation 20°

Compatible with - MICRODENT

MODEL	IMPLANT DIAMETER	PLATFORM	(R) NON-ENGAGING (NR) ENGAGING	DYNAMIC ABUTMENT®			
				POM	COBALT-CHROME	DYNAMIC SCREW	ANALOG
Universal	2,8/3,25	3,5	R	21.522.003.01-2	21.222.003.01-2	41.318.044.01-2	
	2,8/3,25	3,5	NR	21.512.003.01-2	21.212.003.01-2	41.318.044.01-2	
	3,3/3,5/3,75/4	4,1	R	21.523.024.01-2	21.223.024.01-2	41.320.060.01-2	22.613.024.01-2
	3,3/3,5/3,75/4	4,1	NR	21.513.024.01-2	21.213.024.01-2	41.320.060.01-2	22.613.024.01-2
	4,2/5	5,1	R	21.524.058.01-2		41.320.060.01-2	
	4,2/5	5,1	NR	21.514.058.01-2		41.320.060.01-2	
System	2,8/3,25	3,5	R	21.522.003.01-2	21.222.003.01-2	41.318.044.01-2	
	2,8/3,25	3,5	NR	21.512.003.01-2	21.212.003.01-2	41.318.044.01-2	
Ektos	3,7/4,2	3,5	R	21.522.040.01-2	21.222.040.01-2	41.318.075.01-2	
	3,7/4,2	3,5	NR	21.512.040.01-2	21.212.040.01-2	41.318.075.01-2	

Compatible with - MIS

MODEL	IMPLANT DIAMETER	PLATFORM	(R) NON-ENGAGING (NR) ENGAGING	DYNAMIC ABUTMENT®			
				POM	COBALT-CHROME	DYNAMIC SCREW	ANALOG
Lance	3,75/4,2	Standard	R	21.523.024.01-2	21.223.024.01-2	41.320.060.01-2	22.613.024.01-2
	3,75/4,2	Standard	NR	21.513.024.01-2	21.213.024.01-2	41.320.060.01-2	22.613.024.01-2
	5	Wide	R	21.524.058.01-2		41.320.060.01-2	22.614.058.01-2
	5	Wide	NR	21.514.058.01-2		41.320.060.01-2	22.614.058.01-2
Seven	3,75/4,2	Standard	R	21.522.040.01-2	21.222.040.01-2	41.317.071.01-2	22.612.040.01-2
	3,75/4,2	Standard	NR	21.512.040.01-2	21.212.040.01-2	41.317.071.01-2	22.612.040.01-2
	5/6	Wide	R	21.523.041.01-2	21.223.041.01-2	41.317.071.01-2	22.613.041.01-2
	5/6	Wide	NR	21.513.041.01-2	21.213.041.01-2	41.317.071.01-2	22.613.041.01-2
M4	3,75/4,2	Standard	R	21.522.040.01-2	21.222.040.01-2	41.317.071.01-2	22.612.040.01-2
	3,75/4,2	Standard	NR	21.512.040.01-2	21.212.040.01-2	41.317.071.01-2	22.612.040.01-2
	5/6	Wide	R	21.523.041.01-2	21.223.041.01-2	41.317.071.01-2	22.613.041.01-2
	5/6	Wide	NR	21.513.041.01-2	21.213.041.01-2	41.317.071.01-2	22.613.041.01-2

Compatible with - MOZO-GRAU

MODEL	IMPLANT DIAMETER	PLATFORM	(R) NON-ENGAGING (NR) ENGAGING	DYNAMIC ABUTMENT®			
				POM	COBALT-CHROME	DYNAMIC SCREW	ANALOG
MG Osseous	3,3	3,4 Mini	R	21.522.003.01-2	21.222.003.01-2	41.320.065.01-2	22.612.003.01-2
	3,3	3,4 Mini	NR	21.512.003.01-2	21.212.003.01-2	41.320.065.01-2	22.612.003.01-2
	3,4/3,75/4,25	4,1 Standard	R	21.523.024.01-2	21.223.024.01-2	41.320.060.01-2	22.613.024.01-2
	3,4/3,75/4,25	4,1 Standard	NR	21.513.024.01-2	21.213.024.01-2	41.320.060.01-2	22.613.024.01-2
	5	5 Maxi	R	21.524.061.01-2	21.224.061.01-2	41.325.067.01-2	22.614.061.01-2
	5	5 Maxi	NR	21.514.061.01-2	21.214.061.01-2	41.325.067.01-2	22.614.061.01-2
MG Inhex		Con 20°	R	21.523.066.01-2		41.314.040.01-2	
		Con 45°	R	21.523.067.01-2		41.314.040.01-2	
	3,75/4,25	2,8 Standard	R	21.523.004.01-2	21.223.004.01-2	41.316.076.01-2	22.613.004.01-2
	3,75/4,25	2,8 Standard	NR	21.513.004.01-2	21.213.004.01-2	41.316.076.01-2	22.613.004.01-2

Compatible with - MPI

MODEL	IMPLANT DIAMETER	PLATFORM	(R) NON-ENGAGING (NR) ENGAGING	DYNAMIC ABUTMENT®			
				POM	COBALT-CHROME	DYNAMIC SCREW	ANALOG
External Connection HE	3,3	3,5	R	21.522.009.01-2	21.222.009.01-2	41.320.060.01-2	
	3,3	3,5	NR		21.212.009.01-2	41.320.060.01-2	
	3,3/4	4,1	R	21.523.024.01-2	21.223.024.01-2	41.320.060.01-2	22.613.024.01-2
	3,3/4	4,1	NR	21.513.024.01-2	21.213.024.01-2	41.320.060.01-2	22.613.024.01-2
	5	5	R	21.524.058.01-2		41.320.047.01-2	22.614.058.01-2
	5	5	NR	21.514.058.01-2		41.320.047.01-2	22.614.058.01-2
Internal Connection	3,5/4	Regular	R	21.523.004.01-2	21.223.004.01-2	41.316.076.01-2	22.613.004.01-2
	3,5/4	Regular	NR	21.513.004.01-2	21.213.004.01-2	41.316.076.01-2	22.613.004.01-2

Compatible with - NEOBIOTECH

MODEL	IMPLANT DIAMETER	PLATFORM	(R) NON-ENGAGING (NR) ENGAGING	DYNAMIC ABUTMENT®			
				POM	COBALT-CHROME	DYNAMIC SCREW	ANALOG
EB External System	3,5	Narrow	R	21.522.023.01-2	21.222.023.01-2	41.316.059.01-2	22.612.023.01-2
	3,5	Narrow	NR	21.512.023.01-2	21.212.023.01-2	41.316.059.01-2	22.612.023.01-2
IS Implant System	4	Regular 4	R	21.523.030.01-2	21.223.030.01-2	41.320.079.01-2	
	4	Regular 4	NR	21.513.030.01-2	21.213.030.01-2	41.320.079.01-2	
	4,5	Regular 4,5	R	21.523.030.01-2	21.223.030.01-2	41.320.079.01-2	
	4,5	Regular 4,5	NR	21.513.030.01-2	21.213.030.01-2	41.320.079.01-2	
	5	Wide 5	R	21.523.030.01-2	21.223.030.01-2	41.320.079.01-2	
	5	Wide 5	NR	21.513.030.01-2	21.213.030.01-2	41.320.079.01-2	
		4,8	R	21.523.025.01-2	21.223.025.01-2	41.314.040.01-2	22.613.025.01-2

Compatible with - NEODENT

MODEL	IMPLANT DIAMETER	PLATFORM	(R) NON-ENGAGING (NR) ENGAGING	DYNAMIC ABUTMENT®			
				POM	COBALT-CHROME	DYNAMIC SCREW	ANALOG
Cone Morse Mini Pilar		Regular	R	21.523.025.01-2	21.223.025.01-2	41.314.040.01-2	22.613.025.01-2
Smart HE	3,75/4	4,1	R	21.523.024.01-2	21.223.024.01-2	41.320.070.01-2*	22.613.024.01-2
	3,75/4	4,1	NR	21.513.024.01-2	21.213.024.01-2	41.320.070.01-2*	22.613.024.01-2

*Use 41.320.060.01-2 screw for original analog

Compatible with - NOBEL BIOCARE

MODEL	IMPLANT DIAMETER	PLATFORM	(R) NON-ENGAGING (NR) ENGAGING	DYNAMIC ABUTMENT®			
				POM	COBALT-CHROME	DYNAMIC SCREW	ANALOG
Branemark	3,3	Narrow	R	21.522.023.01-2	21.222.023.01-2	41.316.059.01-2	22.612.023.01-2
	3,3	Narrow	NR	21.512.023.01-2	21.212.023.01-2	41.316.059.01-2	22.612.023.01-2
	3,75/4	Regular	R	21.523.024.01-2	21.223.024.01-2	41.320.060.01-2	22.613.024.01-2
	3,75/4	Regular	NR	21.513.024.01-2	21.213.024.01-2	41.320.060.01-2	22.613.024.01-2
	5/6	Wide	R	21.524.061.01-2	21.224.061.01-2	41.325.067.01-2	22.614.061.01-2
	5/6	Wide	NR	21.514.061.01-2	21.214.061.01-2	41.325.067.01-2	22.614.061.01-2
Multi-Unit		Regular	R	21.523.025.01-2	21.223.025.01-2	41.314.040.01-2	22.613.025.01-2
		Wide	R	21.524.068.01-2		41.318.044.01-2	
Standard		Regular	R			41.314.045.01-2	
Replace	3,5	Narrow	R	21.522.026.01-2	21.222.026.01-2	41.318.075.01-2	22.612.026.01-2
	3,5	Narrow	NR	21.512.026.01-2	21.212.026.01-2	41.318.075.01-2	22.612.026.01-2
	4,3*	Regular	R	21.523.027.01-2	21.223.027.01-2	41.320.082.01-2	22.613.027.01-2
	4,3*	Regular	NR	21.513.027.01-2	21.213.027.01-2	41.320.082.01-2	22.613.027.01-2
Active	3,5	Narrow	R	21.522.021.01-2	21.222.021.01-2	41.316.073.01-2	22.612.021.01-2
	3,5	Narrow	NR	21.512.021.01-2	21.212.021.01-2	41.316.073.01-2	22.612.021.01-2
	4,3/5	Regular	R	21.523.022.01-2	21.223.022.01-2	41.320.075.01-2	22.613.022.01-2
	4,3/5	Regular	NR	21.513.022.01-2	21.213.022.01-2	41.320.075.01-2	22.613.022.01-2

*Maximum angulation 20°

Compatible with - NORMON

MODEL	IMPLANT DIAMETER	PLATFORM	(R) NON-ENGAGING (NR) ENGAGING	DYNAMIC ABUTMENT®			
				POM	COBALT-CHROME	DYNAMIC SCREW	ANALOG
Normo implant HE	3,25/3,75/4,25/4,75	4,1	R	21.523.024.01-2	21.223.024.01-2	41.320.060.01-2	22.613.024.01-2
	3,25/3,75/4,25/4,75	4,1	NR	21.513.024.01-2	21.213.024.01-2	41.320.060.01-2	22.613.024.01-2

Compatible with - OSSEOLIFE (ZIACOM)

MODEL	IMPLANT DIAMETER	PLATFORM	(R) NON-ENGAGING (NR) ENGAGING	DYNAMIC ABUTMENT®			
				POM	COBALT-CHROME	DYNAMIC SCREW	ANALOG
OEX	3,75/4,25	RP 4,1	R	21.523.024.01-2	21.223.024.01-2	41.320.060.01-2	22.613.024.01-2
	3,75/4,25	RP 4,1	NR	21.513.024.01-2	21.213.024.01-2	41.320.060.01-2	22.613.024.01-2

Compatible with - OSSTEM IMPLANT

MODEL	IMPLANT DIAMETER	PLATFORM	(R) NON-ENGAGING (NR) ENGAGING	DYNAMIC ABUTMENT®			
				POM	COBALT-CHROME	DYNAMIC SCREW	ANALOG
TS	4/4,5/5/6/7	Regular*	R	21.523.030.01-2	21.223.030.01-2	41.320.079.01-2	
	4/4,5/5/6/7	Regular*	NR	21.513.030.01-2	21.213.030.01-2	41.320.079.01-2	
US	3,3/3,5	Mini 3,5	R	21.522.023.01-2	21.222.023.01-2	41.316.059.01-2	22.612.023.01-2
	3,3/3,5	Mini 3,5	NR	21.512.023.01-2	21.212.023.01-2	41.316.059.01-2	22.612.023.01-2
	3,75/4/4,5	Regular 4,1	R	21.523.024.01-2	21.223.024.01-2	41.320.060.01-2	22.613.024.01-2
	3,75/4/4,5	Regular 4,1	NR	21.513.024.01-2	21.213.024.01-2	41.320.060.01-2	22.613.024.01-2
	5/5,5	Wide 5,1	R	21.524.061.01-2	21.224.061.01-2	41.325.067.01-2	22.614.061.01-2
	5/5,5	Wide 5,1	NR	21.514.061.01-2	21.214.061.01-2	41.325.067.01-2	22.614.061.01-2
	5/5,5	Wide PS 5	R	21.524.058.01-2		41.320.060.01-2	22.614.058.01-2
	5/5,5	Wide PS 5	NR	21.514.058.01-2		41.320.060.01-2	22.614.058.01-2
TS	3,5	Mini	R	--	21.222.029.01-2	41.316.088.01-2	
	3,5	Mini	NR	--	21.212.029.01-2	41.316.088.01-2	

*Maximum angulation 20°

Compatible with - OSTEOPUS

MODEL	IMPLANT DIAMETER	PLATFORM	(R) NON-ENGAGING (NR) ENGAGING	DYNAMIC ABUTMENT®			
				POM	COBALT-CHROME	DYNAMIC SCREW	ANALOG
Argentium	3,8/4,2/4,8	4,2	R	21.523.062.01-2		41.318.065.01-2	
	3,8/4,2/4,8	4,2	NR			41.318.065.01-2	
Iridium	3,8/4,2/4,8	4,2*	R	21.523.062.01-2		41.318.075.01-2	
	3,8/4,2/4,8	4,2*	NR			41.318.075.01-2	
She	3,45	3,45	R	21.522.009.01-2	21.222.009.01-2	41.320.065.01-2	
	3,45	3,45	NR	21.212.009.01-2		41.320.065.01-2	
	3,75 / 4	4	R	21.523.024.01-2	21.223.024.01-2	41.320.065.01-2	22.613.024.01-2
	3,75 / 4	4	NR	21.513.024.01-2	21.213.024.01-2	41.320.065.01-2	22.613.024.01-2
Shi	3,3 / 3,75 / 4,2	3,5	R	21.522.040.01-2	21.222.040.01-2	41.317.071.01-2	22.612.040.01-2
	3,3 / 3,75 / 4,2	3,5	NR	21.512.040.01-2	21.212.040.01-2	41.317.071.01-2	22.612.040.01-2

*Maximum angulation 20°

Compatible with - PALTOP

MODEL	IMPLANT DIAMETER	PLATFORM	(R) NON-ENGAGING (NR) ENGAGING	DYNAMIC ABUTMENT®			
				POM	COBALT-CHROME	DYNAMIC SCREW	ANALOG
Conical Active	3,75/4,2/5	Standard	R	--	21.222.029.01-2	41.316.088.01-2	
	3,75/4,2/5	Standard	NR	--	21.212.029.01-2	41.316.088.01-2	

Compatible with - PHIBO

MODEL	IMPLANT DIAMETER	PLATFORM	(R) NON-ENGAGING (NR) ENGAGING	DYNAMIC ABUTMENT®			
				POM	COBALT-CHROME	DYNAMIC SCREW	ANALOG
TSA Serie 3	3,6	3,7	R	21.522.072.01-2		41.316.076.01-2	
	3,6	3,7	NR			41.316.076.01-2	
TSA Serie 4	4,2	4,7	R	21.523.073.01-2		41.318.075.01-2	22.613.073.01-2
	4,2	4,7	NR			41.318.075.01-2	22.613.073.01-2
TSA Serie 5	5,5	6	R	21.523.073.01-2		41.318.075.01-2	
	5,5	6	NR			41.318.075.01-2	
TSH Serie 2	3,3	3,3	R	21.222.023.01-2		41.318.065.01-2	
TSH/BNT Serie 3	3,6	4	R	21.523.024.01-2	21.223.024.01-2	41.320.060.01-2	22.613.024.01-2
	3,6	4	NR	21.513.024.01-2	21.213.024.01-2	41.320.060.01-2	22.613.024.01-2
TSH/BNT Serie 4	4,2	4	R	21.523.024.01-2	21.223.024.01-2	41.320.060.01-2	22.613.024.01-2
	4,2	4	NR	21.513.024.01-2	21.213.024.01-2	41.320.060.01-2	22.613.024.01-2
TSH/BNT Serie 5	4,8	5	R	21.514.060.01-2		41.320.047.01-2	

Compatible with - PROCLINIC

MODEL	IMPLANT DIAMETER	PLATFORM	(R) NON-ENGAGING (NR) ENGAGING	DYNAMIC ABUTMENT®			
				POM	COBALT-CHROME	DYNAMIC SCREW	ANALOG
External Cylinder/ External Conical	3,75/4,25//3,5/4	4,1 Standard	R	21.523.024.01-2	21.223.024.01-2	41.320.060.01-2	22.613.024.01-2
	3,75/4,25//3,5/4	4,1 Standard	NR	21.513.024.01-2	21.213.024.01-2	41.320.060.01-2	22.613.024.01-2
	5	5 Maxi	R	21.524.058.01-2		41.320.065.01-2	
	5	5 Maxi	NR	21.514.058.01-2		41.320.065.01-2	
Internal Cylinder/ Internal Conical	3,3/3,75/4,25/5//3,5/4/5	3,5	R	21.522.040.01-2	21.222.040.01-2	41.317.071.01-2	22.612.040.01-2
	3,3/3,75/4,25/5//3,5/4/5	3,5	NR	21.512.040.01-2	21.212.040.01-2	41.317.071.01-2	22.612.040.01-2
SP Octa	3,3/4,1/4,8	4,8	R*	21.523.074.01-2		41.320.050.01-2	22.613.074.01-2
	3,3/4,1/4,8	4,8	NR*	21.513.074.01-2		41.320.050.01-2	22.613.074.01-2

*Converter needed for this compatibility:
Screwdriver converter: 43.601.107.01-2

Compatible with -RADHEX

MODEL	IMPLANT DIAMETER	PLATFORM	(R) NON-ENGAGING (NR) ENGAGING	DYNAMIC ABUTMENT®			
				POM	COBALT-CHROME	DYNAMIC SCREW	ANALOG
PHE	3,5	3,5	R	21.522.023.01-2	21.222.023.01-2	41.316.076.01-2	
	3,5	3,5	NR	21.512.023.01-2	21.212.023.01-2	41.316.076.01-2	
	4/4,5/5	4,1	R	21.523.024.01-2	21.223.024.01-2	41.320.065.01-2	22.613.024.01-2
	4/4,5/5	4,1	NR	21.513.024.01-2	21.213.024.01-2	41.320.065.01-2	22.613.024.01-2
PHI	3,75	3,5	R	21.522.040.01-2	21.222.040.01-2	41.318.075.01-2	
	3,75	3,5	NR	21.512.040.01-2	21.212.040.01-2	41.318.075.01-2	
	4,5/5	4,5	R	21.523.041.01-2	21.223.041.01-2	41.318.075.01-2	
	4,5/5	4,5	NR	21.513.041.01-2	21.213.041.01-2	41.318.075.01-2	

Compatible with -SEWON MEDIX

MODEL	IMPLANT DIAMETER	PLATFORM	(R) NON-ENGAGING (NR) ENGAGING	DYNAMIC ABUTMENT®			
				POM	COBALT-CHROME	DYNAMIC SCREW	ANALOG
IH2 SLA SYSTEM	3,5	Mini	R	--	21.222.029.01-2	41.316.088.01-2	
	3,5	Mini	NR	--	21.212.029.01-2	41.316.088.01-2	
IH2 RBM SYSTEM	3,5	Mini	R	--	21.212.029.01-2	41.316.088.01-2	
	3,5	Mini	NR	--	21.222.029.01-2	41.316.088.01-2	

Compatible with - SGS

MODEL	IMPLANT DIAMETER	PLATFORM	(R) NON-ENGAGING (NR) ENGAGING	DYNAMIC ABUTMENT®			
				POM	COBALT-CHROME	DYNAMIC SCREW	ANALOG
P1	3,2/3,75/4,2/5/6	3,75	R	21.522.040.01-2	21.222.040.01-2	41.317.071.01-2	22.612.040.01-2
	3,2/3,75/4,2/5/6	3,75	NR	21.512.040.01-2	21.212.040.01-2	41.317.071.01-2	22.612.040.01-2
P7	3,2/3,75/4,2/4,5/5/6	3,75	NR	21.512.040.01-2	21.212.040.01-2	41.317.071.01-2	22.612.040.01-2
	3,2/3,75/4,2/4,5/5/6	3,75	R	21.522.040.01-2	21.222.040.01-2	41.317.071.01-2	22.612.040.01-2

MODEL	IMPLANT DIAMETER	PLATFORM	(R) NON-ENGAGING (NR) ENGAGING	DYNAMIC ABUTMENT®			
				POM	COBALT-CHROME	DYNAMIC SCREW	ANALOG
Duo	3,8	3,3	R			41.318.065.01-2	
	4,6	4,1	R	21.523.024.01-2	21.223.024.01-2	41.320.074.01-2 (1)	
	4,6	4,1	NR	21.513.024.01-2	21.213.024.01-2	41.320.074.01-2 (1)	
Integra	3,25	3,3	R			41.318.065.01-2 (2)	
	3,25	3,3	NR	21.512.078.01-2		41.318.065.01-2 (2)	
	3,75/4	4,1	R	21.523.024.01-2	21.223.024.01-2	41.320.074.01-2 (1)	
Compact	3,75/4	4,1	NR	21.513.024.01-2	21.213.024.01-2	41.320.074.01-2 (1)	
	4,5	CM3,8	R	21.523.004.01-2	21.223.004.01-2	41.316.076.01-2	22.613.004.01-2
Duocon	4,5	CM3,8	NR	21.513.004.01-2	21.213.004.01-2	41.316.076.01-2	22.613.004.01-2
	3,8	CM3,8	R	21.523.004.01-2	21.223.004.01-2	41.316.076.01-2	22.613.004.01-2
	3,8	CM3,8	NR	21.513.004.01-2	21.213.004.01-2	41.316.076.01-2	22.613.004.01-2

(1) Use 41.320.060.01-2 screw for original analog
 (2) Use 41.318.044.01-2 screw for original analog

MODEL	IMPLANT DIAMETER	PLATFORM	(R) NON-ENGAGING (NR) ENGAGING	DYNAMIC ABUTMENT®			
				POM	COBALT-CHROME	DYNAMIC SCREW	ANALOG
Tri-Nex	3,5	3,5	R	21.522.026.01-2	21.222.026.01-2	41.318.075.01-2	22.612.026.01-2
	3,5	3,5	NR	21.512.026.01-2	21.212.026.01-2	41.318.075.01-2	22.612.026.01-2
	4,3	4,3	R	21.523.027.01-2	21.223.027.01-2	41.320.082.01-2	22.613.027.01-2
	4,3	4,3	NR	21.513.027.01-2	21.213.027.01-2	41.320.082.01-2	22.613.027.01-2
External Hex	3,25	3,4	R	21.522.003.01-2	21.222.003.01-2	41.320.065.01-2	
	3,75/4	4,1	R	21.523.024.01-2	21.223.024.01-2	41.320.060.01-2	22.613.024.01-2
	3,75/4	4,1	NR	21.513.024.01-2	21.213.024.01-2	41.320.060.01-2	22.613.024.01-2
	4,7/5	5	R	21.524.058.01-2		41.320.047.01-2	22.614.058.01-2
	4,7/5	5	NR	21.514.058.01-2		41.320.047.01-2	22.614.058.01-2
Deep Conical	5,7/6	6	R	21.524.058.01-2		41.320.047.01-2	
	5,7/6	6	NR	21.514.058.01-2		41.320.047.01-2	
Internal Hex	3,5/4	2,95/3,1	R	21.523.004.01-2	21.223.004.01-2	41.316.076.01-2	22.613.004.01-2
	3,5/4	2,95/3,1	NR	21.513.004.01-2	21.213.004.01-2	41.316.076.01-2	22.613.004.01-2
Compact Conical	3,75/4,2/5	Universal	R	21.522.040.01-2	21.222.040.01-2	41.317.071.01-2	22.612.040.01-2
	3,75/4,2/5	Universal	NR	21.512.040.01-2	21.212.040.01-2	41.317.071.01-2	22.612.040.01-2
Compact Conical	4,8	4,8	R	21.523.025.01-2	21.223.025.01-2	41.314.040.01-2	22.613.025.01-2

Compatible with - STRAUMANN

MODEL	IMPLANT DIAMETER	PLATFORM	(R) NON-ENGAGING (NR) ENGAGING	DYNAMIC ABUTMENT®			
				POM	COBALT-CHROME	DYNAMIC SCREW	ANALOG
Synocta		Regular 4,8	R*	21.523.074.01-2		41.320.050.01-2	22.613.074.01-2
		Regular 4,8	NR*	21.513.074.01-2		41.320.050.01-2	22.613.074.01-2
Bone Level	3,3	NC- 3,3	R	21.522.033.01-2	21.222.033.01-2	41.316.078.01-2	22.612.033.01-2
	3,3	NC-3,3	NR	21.512.033.01-2	21.212.033.01-2	41.316.078.01-2	22.612.033.01-2
	4,1	RC-4,1	R	21.523.035.01-2	21.223.035.01-2	41.316.078.01-2	22.613.035.01-2
	4,1	RC-4,1	NR	21.513.035.01-2	21.213.035.01-2	41.316.078.01-2	22.613.035.01-2
	4,8	RC-4,8	R	21.523.035.01-2	21.223.035.01-2	41.316.078.01-2	22.613.035.01-2
	4,8	RC-4,8	NR	21.513.035.01-2	21.213.035.01-2	41.316.078.01-2	22.613.035.01-2

*Converter needed for this compatibility:
Screwdriver converter: 43.601.107.01-2

Compatible with -SYBRON IMPLANTS SOLUTIONS

MODEL	IMPLANT DIAMETER	PLATFORM	(R) NON-ENGAGING (NR) ENGAGING	DYNAMIC ABUTMENT®			
				POM	COBALT-CHROME	DYNAMIC SCREW	ANALOG
Endopore (Innova)	4,1	4,1	R	21.523.024.01-2	21.223.024.01-2	41.320.060.01-2	22.613.024.01-2
	4,1	4,1	NR	21.513.024.01-2	21.213.024.01-2	41.320.060.01-2	22.613.024.01-2

Compatible with - SYSTHEX

MODEL	IMPLANT DIAMETER	PLATFORM	(R) NON-ENGAGING (NR) ENGAGING	DYNAMIC ABUTMENT®			
				POM	COBALT-CHROME	DYNAMIC SCREW	ANALOG
Classic-ci / Estetic-ci	3,5/3,75/4	4,1	R	21.523.024.01-2	21.223.024.01-2	41.320.074.01-2	
	3,5/3,75/4	4,1	NR	21.513.024.01-2	21.213.024.01-2	41.320.074.01-2	
Fit-hex	3,3	3,3	R			41.318.044.01-2	
Classic Traditional	5	5	R			41.325.054.01-2	
	5	5	NR			41.325.054.01-2	

Compatible with -TBR

MODEL	IMPLANT DIAMETER	PLATFORM	(R) NON-ENGAGING (NR) ENGAGING	DYNAMIC ABUTMENT®			
				POM	COBALT-CHROME	DYNAMIC SCREW	ANALOG
Hex-Conic		Narrow	R	21.522.023.01-2	21.222.023.01-2	41.320.060.01-2	
		Narrow	NR	21.512.023.01-2	21.212.023.01-2	41.320.060.01-2	

Compatible with -TITANIUM - FIX

MODEL	IMPLANT DIAMETER	PLATFORM	(R) NON-ENGAGING (NR) ENGAGING	DYNAMIC ABUTMENT®			
				POM	COBALT-CHROME	DYNAMIC SCREW	ANALOG
	3,5/4	Regular	R	21.523.004.01-2	21.223.004.01-2	41.316.076.01-2	22.613.004.01-2
	3,5/4	Regular	NR	21.513.004.01-2	21.213.004.01-2	41.316.076.01-2	22.613.004.01-2

Compatible with - TRI DENTAL IMPLANTS

MODEL	IMPLANT DIAMETER	PLATFORM	(R) NON-ENGAGING (NR) ENGAGING	DYNAMIC ABUTMENT®			
				POM	COBALT-CHROME	DYNAMIC SCREW	ANALOG
TRI-Vent	3,75/4,1/4,7	3,5	R	21.522.040.01-2	21.222.040.01-2	41.317.071.01-2	22.612.040.01-2
	3,75/4,1/4,7	3,5	NR	21.512.042.01-2	21.212.042.01-2	41.317.071.01-2	22.612.040.01-2

Compatible with -TRINON

MODEL	IMPLANT DIAMETER	PLATFORM	(R) NON-ENGAGING (NR) ENGAGING	DYNAMIC ABUTMENT®			
				POM	COBALT-CHROME	DYNAMIC SCREW	ANALOG
Q2	3,5/3,75/4,5	4	R	21.523.024.01-2	21.223.024.01-2	41.320.060.01-2	22.613.024.01-2
	3,5/3,75/4,5	4	NR	21.513.024.01-2	21.213.024.01-2	41.320.060.01-2	22.613.024.01-2
QK	4	4,8	R*	21.523.074.01-2		41.320.050.01-2	22.613.074.01-2
	4	4,8	NR*	21.513.074.01-2		41.320.050.01-2	22.613.074.01-2

*Converter needed for this compatibility:
Screwdriver converter: 43.601.107.01-2

Compatible with - ZIMMER

MODEL	IMPLANT DIAMETER	PLATFORM	(R) NON-ENGAGING (NR) ENGAGING	DYNAMIC ABUTMENT®			
				POM	COBALT-CHROME	DYNAMIC SCREW	ANALOG
Screw-Vent	3,7/4,1	3,5	R	21.522.040.01-2	21.222.040.01-2	41.317.071.01-2	22.612.040.01-2
	3,4/4,1	3,5	NR	21.512.040.01-2	21.212.040.01-2	41.317.071.01-2	22.612.040.01-2
	3,4/4,1	3,5	NR (ZIO)	21.512.042.01-2	21.212.042.01-2	41.317.071.01-2	22.612.040.01-2
	4,7	4,5	R	21.523.041.01-2	21.223.041.01-2	41.317.071.01-2	22.613.041.01-2
	4,7	4,5	NR	21.513.041.01-2	21.213.041.01-2	41.317.071.01-2	22.613.041.01-2
	4,7	4,5	NR (ZIO)	21.513.043.01-2	21.213.043.01-2	41.317.071.01-2	22.613.041.01-2
Swiss-Plus	3,7/4,1/4,8	4,8	R*	21.523.074.01-2		41.320.050.01-2	22.613.074.01-2
	3,7/4,1/4,8	4,8	NR*	21.513.074.01-2		41.320.050.01-2	22.613.074.01-2

*Converter needed for this compatibility:
Screwdriver converter: 43.601.107.01-2

DYNAMIC SCREWS TECHNICAL SPECIFICATIONS



REFERENCE	METRIC	TORQUE	TOTAL LENGTH	THREAD LENGTH	A LENGTH	B LENGTH	C LENGTH	HEAD DIAMETER	SEAT	ANGLE	THREAD ENTRY	CONNECTION
41.314.039.01-2	1,4	15 N·cm	3,90	1,80	2,10	-	1,80	2,40	staight	-	45° Chamfer	Hexalobular 1,70
41.314.040.01-2	1,4	15 N·cm	4,00	1,85	2,00	2,78	1,22	2,30	conical	30°	45° Chamfer	
41.314.045.01-2	1,4	15 N·cm	4,50	2,30	2,50	3,28	1,22	2,30	conical	30°	45° Chamfer	
41.314.052.01-2	1,4	15 N·cm	5,20	2,90	3,40	-	1,80	2,30	staight	-	45° Chamfer	
41.314.064.01-2	1,4	15 N·cm	6,40	2,20	4,21	5,15	1,25	2,30	conical	25°	45° Chamfer	
41.314.067.01-2	1,4	15 N·cm	6,70	2,31	5,00	5,45	1,25	2,30	conical	45°	45° Chamfer	
41.314.070.01-2	1,4	15 N·cm	7,00	2,30	5,39	5,65	1,61	2,30	conical	60°	45° Chamfer	
41.314.074.01-2	1,4	15 N·cm	7,40	3,55	5,00	5,99	1,41	2,30	conical	25°	45° Chamfer	
41.316.044.01-2	1,6	20 N·cm	4,40	2,50	2,90	-	1,50	2,30	staight	-	Semi-sphere	
41.316.059.01-2	1,6	20 N·cm	5,90	3,00	4,40	-	1,50	2,30	staight	-	Semi-sphere	
41.316.071.01-2	1,6	20 N·cm	7,10	2,80	5,20	5,53	1,57	2,30	conical	60°	45° Chamfer	
41.316.072.01-2	1,6	20 N·cm	7,20	3,50	5,20	5,85	1,35	2,30	conical	30°	45° Chamfer	
41.316.073.01-2	1,6	20 N·cm	7,30	2,20	4,87	5,56	1,74	2,30	conical	35°	45° Chamfer	
41.316.074.01-2	1,6	20 N·cm	7,40	2,70	5,50	6,00	1,40	2,30	conical	45°	45° Chamfer	
41.316.076.01-2	1,6	20 N·cm	7,60	3,60	6,10	-	1,50	2,30	staight	-	Semi-sphere	
41.316.078.01-2	1,6	20 N·cm	7,80	2,00	5,36	7,03	0,81	2,30	conical	15°	45° Chamfer	
41.316.081.01-2	1,6	20 N·cm	8,10	3,00	6,35	6,72	1,38	2,30	conical	45°	45° Chamfer	
41.316.084.01-2	1,6	20 N·cm	8,40	3,50	6,80	-	1,60	2,30	staight	-	Semi-sphere	
41.316.088.01-2	1,6	20 N·cm	8,6	3	6,18	6,6	1,82	2,30	conical	45°	45° Chamfer	
41.316.094.01-2	1,6	20 N·cm	9,40	2,90	7,65	8,00	1,40	2,30	conical	45°	45° Chamfer	
41.317.065.01-2	N1-72	25 N·cm	6,50	2,40	4,70	5,18	1,33	2,30	conical	45°	45° Chamfer	
41.317.071.01-2	N1-72	25 N·cm	7,10	2,60	5,56	5,65	1,45	2,30	conical	70°	45° Chamfer	
41.317.073.01-2	N1-72	25 N·cm	7,30	2,50	5,50	5,77	1,53	2,30	conical	60	45° Chamfer	
41.318.044.01-2	1,8	25 N·cm	4,40	2,75	3,00	-	1,40	2,30	staight	-	Semi-sphere	
41.318.045.01-2	1,8	25 N·cm	4,50	2,30	2,81	2,90	1,60	2,30	conical	70°	45° Chamfer	
41.318.048.01-2	1,8	25 N·cm	4,80	2,80	3,22	3,65	1,15	2,30	conical	30°	Semi-sphere	
41.318.051.01-2	1,8	25 N·cm	5,10	2,70	3,55	3,70	1,40	2,30	conical	60°	45° Chamfer	
41.318.052.01-2	1,8	25 N·cm	5,20	2,90	3,65	3,80	1,40	2,30	conical	60°	45° Chamfer	

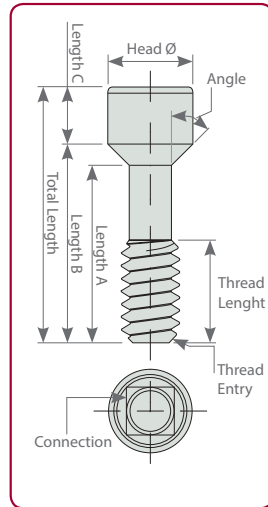
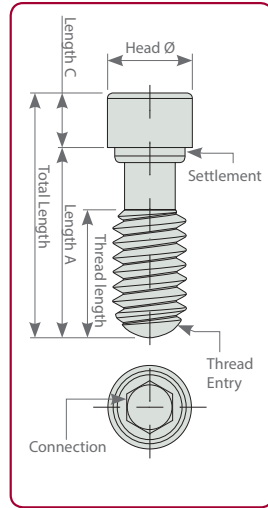

REFERENCE	METRIC	TORQUE	TOTAL LENGTH	THREAD LENGTH	A LENGTH	B LENGTH	C LENGTH	HEAD DIAMETER	SEAT	ANGLE	THREAD ENTRY	CONNECTION
41.318.064.01-2	1,8	25 N·cm	6,40	3,45	4,73	5,10	1,30	2,30	conical	35°	45° Chamfer	Hexalobular 1,70
41.318.065.01-2	1,8	25 N·cm	6,50	2,80	5,00	-	1,50	2,30	straight	-	Semi-sphere	
41.318.066.01-2	1,8	25 N·cm	6,60	4,18	5,05	5,20	1,40	2,30	conical	60°	45° Chamfer	
41.318.067.01-2	1,8	25 N·cm	6,70	2,35	5,00	5,40	1,30	2,30	conical	45°	45° Chamfer	
41.318.068.01-2	1,8	25 N·cm	6,80	4,00	5,25	5,40	1,40	2,30	conical	60°	45° Chamfer	
41.318.071.01-2	1,8	25 N·cm	7,10	2,60	5,56	5,65	1,45	2,30	conical	70°	45° Chamfer	
41.318.074.01-2	1,8	25 N·cm	7,40	3,80	5,80	6,03	1,60	2,30	conical	50°	45° Chamfer	
41.318.075.01-2	1,8	25 N·cm	7,50	3,30	6,10	-	1,40	2,30	straight	-	Semi-sphere	
41.318.076.01-2	1,8	25 N·cm	7,60	2,52	5,80	6,20	1,40	2,30	conical	45°	45° Chamfer	
41.318.080.01-2	1,8	25 N·cm	8,00	4,00	6,50	-	1,50	2,30	straight	-	45° Chamfer	
41.320.047.01-2	2,0	25 N·cm	4,70	3,00	3,30	-	1,40	2,30	straight	-	Semi-sphere	
41.320.048.01-2	2,0	25 N·cm	4,80	2,70	3,30	3,40	1,40	2,30	conical	60°	45° Chamfer	
41.320.049.01-2	2,0	25 N·cm	4,90	2,90	3,40	3,50	1,40	2,30	conical	60°	45° Chamfer	
41.320.050.01-2	2,0	25 N·cm	5,00	2,80	3,39	3,60	1,40	2,30	conical	30°	Semi-sphere	
41.320.051.01-2	2,0	25 N·cm	5,10	3,10	3,60	-	1,50	2,30	straight	-	Semi-sphere	
41.320.060.01-2	2,0	25 N·cm	6,00	2,70	4,50	-	1,50	2,30	straight	-	Semi-sphere	
41.320.065.01-2	2,0	25 N·cm	6,50	2,70	5,00	-	1,50	2,30	straight	-	45° Chamfer	
41.320.066.01-2	2,0	25 N·cm	6,60	4,18	5,11	5,20	1,40	2,30	conical	60°	45° Chamfer	
41.320.067.01-2	2,0	25 N·cm	6,70	2,30	3,65	5,68	1,02	2,58	conical	15°	45° Chamfer	
41.320.068.01-2	2,0	25 N·cm	6,80	4,40	5,30	5,40	1,40	2,30	conical	60°	45° Chamfer	
41.320.070.01-2	2,0	25 N·cm	7,00	3,00	5,60	-	1,40	2,30	straight	-	Semi-sphere	
41.320.074.01-2	2,0	25 N·cm	7,40	3,30	6,00	-	1,40	2,30	straight	-	Semi-sphere	
41.320.075.01-2	2,0	25 N·cm	7,50	2,75	5,93	6,18	1,32	2,30	conical	35°	45° Chamfer	
41.320.079.01-2	2,0	25 N·cm	7,90	3,30	6,33	6,50	1,40	2,30	conical	45°	45° Chamfer	
41.320.082.01-2	2,0	25 N·cm	8,20	4,70	6,70	-	1,50	2,40	straight	-	Semi-sphere	
41.320.090.01-2	2,0	25 N·cm	9,00	4,00	7,50	-	1,50	2,30	straight	-	Semi-sphere	
41.320.094.01-2	2,0	25 N·cm	9,4	3,00	7,85	8,00	1,40	2,30	conical	45°	45° Chamfer	
41.325.054.01-2	2,5	25 N·cm	5,40	3,80	4,10	-	1,30	2,85	straight	-	Semi-sphere	
41.325.067.01-2	2,5	25 N·cm	6,70	4,60	5,10	-	1,60	2,85	straight	-	Semi-sphere	

Straight Screws

They cover all the thread metrics available on the market.
Made of grade 5 Titanium.

Screwdrivers



REF: 43.601.103.02-2
Hex 1.20mm



REF: 43.601.104.01-2
Hex 1.25mm



REF: 43.601.107.01-2
25mm



STRAIGHT SCREWS TECHNICAL SPECIFICATIONS



REFERENCE	METRIC	TORQUE	TOTAL LENGTH	THREAD LENGTH	A LENGTH	B LENGTH	C LENGTH	HEAD DIAMETER	SEAT	ANGLE	THREAD ENTRY	CONNECTION
40.314.008.01-2	1,4	15 N-cm	3,5	1,8	2,1	-	1,4	2	straight	-	45° Chamfer	Unigrip
40.314.005.01-2	1,4	15 N-cm	7,6	3,55	5,17	6	1,6	2,15	conical	25°	45° Chamfer	Hex. 1,27
40.316.008.01-2	1,6	20 N-cm	7	2,7	5,15	-	1,8	2,3	straight	-	45° Chamfer	Unigrip
40.316.008.02-2	1,6	20 N-cm	7,3	2,7	5,15	5,9	1,4	2,2	conical	35°	45° Chamfer	Unigrip
40.316.005.01-2	1,6	20 N-cm	7,5	3,6	5,33	5,85	1,65	2,15	conical	30°	45° Chamfer	Hex. 1,27
40.316.007.01-2	1,6	20 N-cm	7,9	2	5,72	6,9	2,18	2,18	conical	15°	45° Chamfer	Torx T6
40.316.005.03-2	1,6	20 N-cm	8,25	3,03	6,25	-	2	2,45	straight	-	45° Chamfer	Hex. 1,27
40.316.003.01-2	1,6	20 N-cm	8,4	2,5	6,6	-	1,8	2	straight	-	45° Chamfer	Hex. 1,20
40.316.005.04-2	1,6	20 N-cm	10,5	2,9	8,15	8,4	2,1	2,1	conical	45°	45° Chamfer	Hex. 1,27
40.318.005.01-2	1,8	25 N-cm	4,5	2,3	2,8	2,9	1,6	2,35	conical	70°	45° Chamfer	Hex. 1,27
40.318.006.01-2	1,8	25 N-cm	6	3,18	3,5	3,85	2,15	2,4	conical	45°	45° Chamfer	Hex. 1,70
40.318.003.01-2	1,8	25 N-cm	6,8	3,3	5,2	-	1,6	2,3	straight	-	45° Chamfer	Hex. 1,20
40.318.004.01-2	1,8	25 N-cm	7,2	4,47	2,3	6,2	1	2,4	conical	30°	45° Chamfer	Hex. 1,25
40.318.005.02-2	1,8	25 N-cm	7,6	3,8	5,8	6,05	1,55	2,35	conical	50°	45° Chamfer	Hex. 1,27
40.318.008.01-2	1,8	25 N-cm	8,3	2,5	6,5	-	1,8	2,45	straight		45° Chamfer	Unigrip
40.317.004.01-2	N1-72	25 N-cm	7,6	2,8	5,6	5,76	1,84	2,3	conical	70°	45° Chamfer	Hex. 1,25

REFERENCE	METRIC	TORQUE	TOTAL LENGTH	THREAD LENGTH	A LENGTH	B LENGTH	C LENGTH	HEAD DIAMETER	SEAT	ANGLE	THREAD ENTRY	CONNECTION
40.320.003.01-2	2	30 N-cm	4,7	2,7	3,33	-	1,37	2,35	straight	-	45° Chamfer	Hex. 1,20
40.320.007.01-2	2	30 N-cm	6,7	2,25	3,59	5,7	1	2,58	conical	15°	45° Chamfer	Torx T6
40.320.003.02-2	2	30 N-cm	7	3,25	5	-	2	2,4	straight	-	45° Chamfer	Hex. 1,20
40.320.008.01-2	2	30 N-cm	7	3,25	5	-	2	2,4	straight	-	45° Chamfer	Unigrip
40.320.008.02-2	2	30 N-cm	7,3	3	5,8	6,2	1,1	2,5	conical	35°	45° Chamfer	Unigrip
40.320.007.02-2	2	30 N-cm	7,4	3,3	6	-	1,4	2,3	straight	-	Semi-sphere	Torx T6
40.320.003.03-2	2	30 N-cm	7,9	3,7	5,55	6,05	1,8	2,4	conical	45°	45° Chamfer	Hex. 1,20
40.320.007.03-2	2	30 N-cm	7,6	3	6,1	6,3	1,3	2,4	conical	45°	Semi-sphere	Torx T6
40.320.005.01-2	2	30 N-cm	7,6	3,7	6	-	1,6	2,4	straight	-	45° Chamfer	Hex. 1,27
40.320.008.03-2	2	30 N-cm	10	3,6	8,5	-	1,5	2,45	straight	-	45° Chamfer	Unigrip
40.320.002.03-2	2	30 N-cm	10,2	3,15	8,4	-	1,8	2,45	straight	-	45° Chamfer	Sq. 1,30
40.320.005.03-2	2	30 N-cm	10,3	3,5	8,3	-	2	2,33	straight	-	45° Chamfer	Hex. 1,27
40.320.005.04-2	2	30 N-cm	10,5	3,06	8,15	8,4	2,1	2,5	conical	45°	45° Chamfer	Hex. 1,27

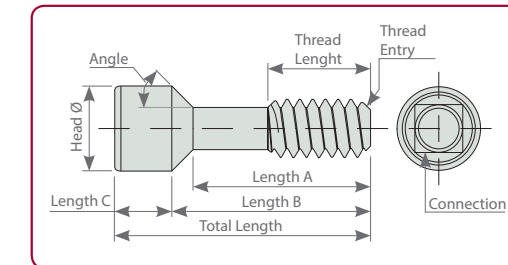
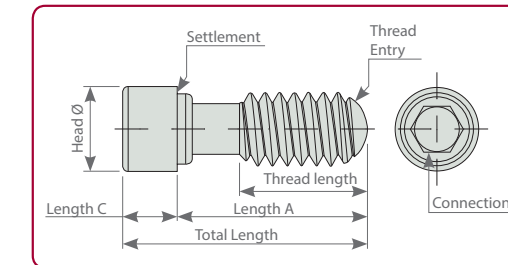

COMPLEMENTS



Manual handle

Made of stainless steel.
They are used to connect screwdriver bits with the contra-angle connection

Large manual handle for laboratory

Ref. 49.601.000.03-2
Ideal to manipulate models in the laboratory.
Length 55.65mm.



Manual handle for clinic

Ref. 49.601.000.01-2
Clinic handle: used to position the prosthesis in the mouth prior to torque control in the clinic. Length: 15.65mm.



Universal manual torque wrench prosthetic

Ref. 11.990.990.07-2

Torque wrench.
4mm square connection. Torque 10-35N.c

Manual torque wrench adapter prosthetic

Piece to connect the screwdriver with contra-angle connection to the torque wrench.



Universal Manual torque wrench adapter

Ref. 49.604.000.05-2
4mm Square connection



Straumann Manual torque wrench adapter

Ref. 49.604.000.07-2
Straumann connection



Nobel Biocare Manual torque wrench adapter

Ref. 49.604.000.08-2

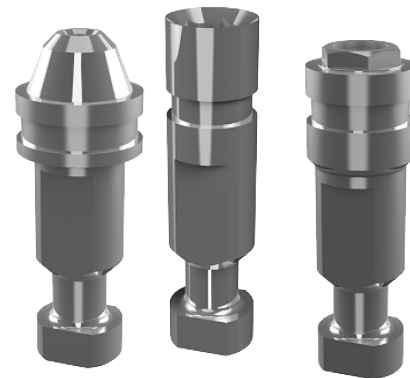

ANALOGS

Stainless steel implant analog. It reproduces the implant connection

PROSTHETIC REAMER

The casting process of the castable cylinders generates imperfections in the final metallic structure. In order to minimize the consequences generated by this process, we have designed a line of tools to correct the base of the cylinder, improving the interior of the chimneys and the adjustment to the implant.

Set of handle and reamer



Ref. 49.604.000.03.2

Chimney Reamer

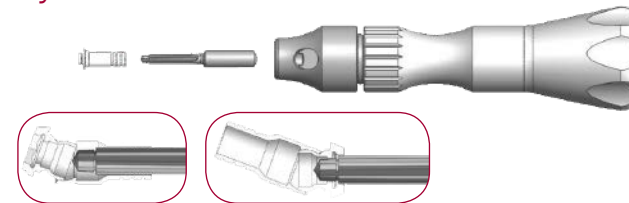

Base Reamer

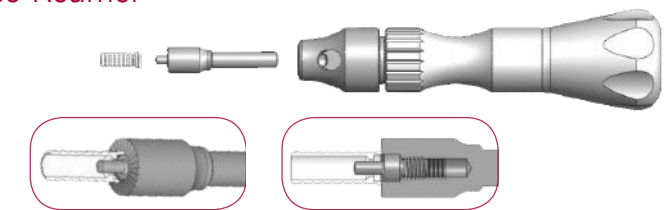

TALLADIUM GUARANTEE

TERMS AND CONDITIONS

These guarantee terms and conditions ("T&C") cover the entire range of Talladium products ("Products"), manufactured by TALLADIUM ESPAÑA S.L. and distributed by Geoda Medical S.L. or official dealers. The guarantee described in these T&C is exclusively in benefit of the clinician ("Clinician") and of the dental technician ("Technician") and not for the benefit of third parties or institutions, including patients.

GUARANTEE PERIOD

TALLADIUM ESPAÑA S.L. offers a lifelong guarantee for its entire range of products starting from the date of issue of the invoice.

GUARANTEE SCOPE

Subject to the limitations and exceptions described in these T&C, TALLADIUM ESPAÑA S.L. will offer the following benefits:

QUALITY: If there are defects in the materials or in the manufacturing of the Product, TALLADIUM ESPAÑA S.L. will replace the Product with no additional cost.

SAFETY: If, having complied with all the product indications, the prosthesis should have to be made again, due to a fault in the Dynamic Abutment® or Dynamic Titanium Base® system, TALLADIUM ESPAÑA S.L. will replace the abutments and screws necessary to remake the prosthesis, as well as the costs derived from its manufacturing.

In case of having used our products and having complied with all the product indications, the implants suffer any damage, TALLADIUM ESPAÑA S.L. will pay the cost of the implants. This coverage will only be valid during the first 6 months after the collocation of the prosthesis which includes our products.

CLAIM REQUIREMENTS AND PROCEDURE

To receive the benefits indicated in these T&C, the treating Clinician must satisfy the following requirements:

- The claim must be notified to TALLADIUM ESPAÑA S.L. within (30) days since the date the claimed defect was detected.
- This requires that the Clinician or Technician must contact the customer service department by telephone or by e-mail to make the claim.
- A claim form will be completed, which, together with a document or report which justifies the faulty Product and the faulty Product itself, will be sent by the customer to TALLADIUM ESPAÑA S.L. offices, within the previously indicated period.
- Clinicians or Technicians presenting a claim in agreement with these T&C must be up to date in any payments owing to TALLADIUM ESPAÑA S.L. or to any of its subsidiaries, at the time when the claim form is presented.
- All the use procedures of our Products must be carried out in agreement with the instructions of TALLADIUM ESPAÑA S.L. as well as in accordance with commonly accepted dentistry practices.
- The expenses derived from this procedure will be assumed by the customer. The return shipping costs will be assumed by TALLADIUM ESPAÑA S.L. in all those cases covered by these T&C.

Regardless of the guarantee rights, claims should be notified as soon as possible in order to comply with regulatory requirements.

GENERAL LIMITATIONS OF THIS GUARANTEE

With the exception of the guarantee described in these T&C, neither TALLADIUM ESPAÑA S.L. nor its representatives, nor third parties manufacturing or distributing the Products, represent or offer a guarantee, agreement or any other express or implicit, oral or written, commitment, with respect to the Products (without limitation), including guarantees involved in the marketing, durability or suitability for individual uses or purposes.

In addition and within the maximum extent permitted by the relative law, TALLADIUM ESPAÑA S.L. rejects (on its own behalf, and on behalf of its representatives and third parties that manufacture or distribute Products) any responsibility with respect to any direct or indirect damage caused, which may result from or be a consequence of the design, composition of the dental prosthesis into which the Products are integrated.

GUARANTEE EXCLUSIONS

TALLADIUM ESPAÑA S.L. limits this guarantee to:

- Transformed abutments that form part of the dental prosthesis. But not the screws used to anchor them.
- Problems derived from the use of laboratory screws for the definite fixation of the prosthesis. TALLADIUM ESPAÑA S.L. has clinical screws that satisfy that function.
- Clinical screws that have been in the mouth for more than 2 years, as it is understood that the patient has to have annual check-ups with the subsequent change of screws.
- The fault is due to normal wear and tear.

AMENDMENT OR SUSPENSION OF THE GUARANTEE

TALLADIUM ESPAÑA S.L. reserves the right to amend or withdraw these T&C at any time and without prior notification. Any modification or suspension shall not affect products already placed in patients.

Ed. 2017-01



DYNAMIC ABUTMENT SOLUTIONS

AV. BLONDEL, 54 3º · 25002 · LLEIDA (SPAIN)
TEL. +34 973 289 580
das@dynamicabutment.com
www.dynamicabutment.com

Visit our Online Store to find all our products and compatibilities :

www.dynamicabutmentstore.com



See our CadCam catalogues EXTRAORAL SOLUTIONS and INTRAORAL SOLUTIONS
Download in our website: www.dynamicabutment.com



VIRGINIA WOOLF, 17 · 25005 · LLEIDA
(SPAIN) TEL. +34 973 289 580
das@dynamicabutment.com
www.dynamicabutment.com

DYNAMIC ABUTMENT® SOLUTIONS